

ifm electronic



7415 x

Made in Germany

2010



fluid sensors
and diagnostic
systems

position
sensors
and object
recognition

bus,
identification
and control systems

ifm electronic – close to you!



- Inductive proximity sensors for all industries.
- Wide choice of housing styles and operating voltages.
- High-quality housing materials.
- Cylindrical housings from 3 to 34 mm diameter, various rectangular housings.
- Large supporting range of mounting and wiring accessories.

Inductive sensors

In all automated processes sensors are absolutely necessary to provide the PLC with information. They supply the necessary signals on positions, limits or serve as pulse pick-ups for counting tasks or for monitoring rotational speed. Inductive and capacitive sensors are nowadays indispensable for industrial usage. As compared to mechanical switches they offer ideal conditions: non-contact operation free from any wear and tear, high switching frequencies and accuracy. In addition, they are insensitive to vibration, dust and moisture. Inductive sensors detect all metals without contact, capacitive sensors almost all solid and liquid media such as metal, glass, wood, plastic, water, oil, etc.

Operating principle of inductive sensors

Inductive sensors take advantage of the physical effect of the change in the quality factor in a resonant circuit caused by eddy current losses in conductive materials. This is how it works: A LC tuned circuit generates a high frequency electromagnetic field. This field is radiated from the active face of the sensor. If a conductive material enters this field, eddy currents will be formed in accordance with the law of inductance which draw energy from the oscillator. This reduces the oscillation amplitude. The change is converted into a switching signal. The operating principle permits detection of all metals irrespective of whether they are moving or not. The distance to the active face at which an electrically conductive material causes a change of signal in the sensor is called sensing range. The sensing range of an inductive sensor is defined by means of a target of mild steel (Fe 360). If the switch is damped by other metals, e.g. aluminium or copper, this is reduced. Using correction factors the user can calculate the attainable sensing ranges.

Application sensors

Every application has its own requirements as regards the sensors to be used. Temperature shocks, mechanical influences or aggressive cleaning agents are just a few of the possible environmental influences to which sensors are subjected. ifm electronic therefore offers inductive sensors which have been developed for special applications. This includes for example the use of selected housing materials such as stainless steel, LCP, PEEK, PBT or Duroplast. An innovative, consistent sealing concept from the sensor to the connector ensures ideal protection against ingress of moisture and aggressive media.







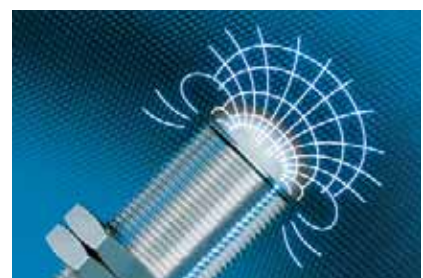







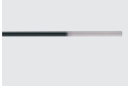





Typical application: Positioning sensing in automation technology; proximity sensors operate reliably and without wear.

















High frequency electromagnetic field: The inductive sensor detects all metals.





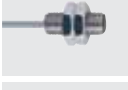

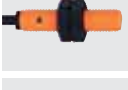
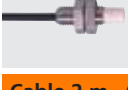

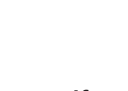













Sensors for industrial applications, DC



















Type	Dimensions [mm]	Sensing range [mm]	Material	U _b [V]	Protection	f [Hz]	I _{load} [mA]	Draw- ing no.	Order no.
Cable 2 m · Output function  · DC PNP · Wiring diagram no. 1									
	Ø 4 / L = 30	0.8 f	stainless steel	10...36	IP65	2000	100	1	IZ5026
	Ø 4 / L = 23	0.8 f	stainless steel	10...30	IP65	2000	100	2	IZ5051
	Ø 3 / L = 27	1 nf	stainless steel	10...30	IP67	5000	100	3	IZ5048
	Ø 4 / L = 23	1.2 f	stainless steel	10...30	IP65	> 2000	100	2	IZ5052
	Ø 4 / L = 27	1.5 nf	stainless steel	10...30	IP67	1800	100	4	IZ5047
M8 connector · Output function  · DC PNP · Wiring diagram no. 2									
	Ø 4 / L = 45	0.8 f	stainless steel	10...36	IP65	2000	100	5	IZ5035
	Ø 4 / L = 41	1.5 nf	stainless steel	10...30	IP67	1800	100	6	IZ5046
Cable 2 m · Output function  · DC PNP · Wiring diagram no. 1									
	M5 / L = 30	0.8 f	stainless steel	10...36	IP65	2000	100	7	IY5029
	M5 / L = 23	0.8 f	stainless steel	10...30	IP65	2000	100	8	IY5051
	M5 / L = 27	1.5 nf	stainless steel	10...30	IP67	1800	100	9	IY5049
M8 connector · Output function  · DC PNP · Wiring diagram no. 2									
	M5 / L = 45	0.8 f	stainless steel	10...36	IP65	2000	100	10	IY5036
	M5 / L = 41	1.5 nf	stainless steel	10...30	IP67	1800	100	11	IY5048
Cable 2 m · Output function  · DC PNP · Wiring diagram no. 1									
	Ø 6.5 / L = 35	1 f	brass	10...36	IP67	900	200	12	IT5001
	Ø 6.5 / L = 19	2 f	stainless steel	10...30	IP67	1000	200	13	IT5039



















Inductive sensors

Type	Dimensions [mm]	Sensing range [mm]	Material	U _b [V]	Protection	f [Hz]	I _{load} [mA]	Draw- ing no.	Order no.
Cable 2 m · Output function  · DC PNP · Wiring diagram no. 1									
	Ø 6.5 / L = 27	2 f	high-grade st. steel	10...30	IP67	1500	100	14	IT5042
	Ø 6.5 / L = 27	4 nf	high-grade st. steel	10...30	IP67	500	100	15	IT5043
M8 connector · Output function  · DC PNP · Wiring diagram no. 2									
	Ø 6.5 / L = 49	1 f	high-grade st. steel	10...36	IP65	1500	200	16	IT5021
	Ø 6.5 / L = 49	1.5 f	brass	10...36	IP65	2000	250	16	IT5034
	Ø 6.5 / L = 30	2 f	high-grade st. steel	10...30	IP67	1500	100	17	IT5040
	Ø 6.5 / L = 30	4 nf	high-grade st. steel	10...30	IP67	700	100	18	IT5041
	Ø 6.5 / L = 50	4 nf	high-grade st. steel	10...30	IP67	300	100	19	IT5044
Cable 2 m · Output function  · DC PNP · Wiring diagram no. 1									
	M8 / L = 35	1 f	brass	10...36	IP67	750	200	20	IE5072
	M8 / L = 50	1 f	brass	10...36	IP67	750	200	21	IE5121
	M8 / L = 50	1 f	PBT	10...36	IP67	1000	200	21	IE5129
	M8 / L = 20	1.5 f	stainless steel	10...30	IP67	1000	200	22	IE5348
	M8 / L = 27	2 f	high-grade st. steel	10...30	IP67	1500	100	23	IE5368
	M8 / L = 35	2 nf	PBT	10...36	IP67	800	200	20	IE5099
	M8 / L = 27	4 nf	high-grade st. steel	10...30	IP67	500	100	24	IE5369
Cable 2 m · Output function  · DC PNP/NPN · Wiring diagram no. 26									
	M8 / L = 50	1 f	brass	5...36	IP67	2000	200	21	IE5222



























Type	Dimensions [mm]	Sensing range [mm]	Material	U _b [V]	Protection	f [Hz]	I _{load} [mA]	Drawing no.	Order no.
Cable 2 m · Output function  /  · DC PNP/NPN · Wiring diagram no. 26									
	M8 / L = 50	2 nf	brass	5...36	IP67	2700	200	25	IE5238
	M8 / L = 50	2 nf	PBT (Pocan)	5...36	IP67	2000	200	21	IE5202
Cable 2 m · Output function  · 3-wire DC PNP; 2-wire DC PNP/NPN · Wiring diagram no. 27									
	M8 / L = 37	3 f	brass	10...30	IP67	1000	100	26	IE5343
	M8 / L = 37	5 nf	brass	10...30	IP67	700	100	27	IE5345
Cable with connector 0.3 m · Output function  · 3-wire DC PNP; 2-wire DC PNP/NPN · Wiring diagram no. 28									
	M8 / L = 37	3 f	brass	10...30	IP67	1000	100	26	IE5344
	M8 / L = 37	5 nf	brass	10...30	IP67	700	100	27	IE5346
	M8 / L = 37	3 f	brass	10...30	IP67	1000	100	26	IE5351
	M8 / L = 37	5 nf	brass	10...30	IP67	700	100	27	IE5352
M8 connector · Output function  · DC PNP · Wiring diagram no. 2									
	M8 / L = 50	2 f	brass	10...36	IP67	1000	250	28	IE5287
	M8 / L = 30	2 f	high-grade st. steel	10...30	IP67 /	1500	100	29	IE5366
	M8 / L = 30	4 nf	high-grade st. steel	10...30	IP67	700	100	30	IE5367
M8 connector · Output function  · DC PNP · Wiring diagram no. 3									
	M8 / L = 50	1 f	high-grade st. steel	10...36	IP65	1500	200	31	IE5258
M8 connector · Output function  · 3-wire DC PNP; 2-wire DC PNP/NPN · Wiring diagram no. 28									
	M8 / L = 40	3 f	brass	10...30	IP67	1000	100	32	IE5338
	M8 / L = 40	5 nf	high-grade st. steel	10...30	IP67	700	100	33	IE5340



















Inductive sensors

Type	Dimensions [mm]	Sensing range [mm]	Material	U _b [V]	Protection	f [Hz]	I _{load} [mA]	Draw- ing no.	Order no.
M8 connector · Output function  · 3-wire DC PNP; 2-wire DC PNP/NPN · Wiring diagram no. 29									
	M8 / L = 40	3 f	brass	10...30	IP67	1000	100	34	IE5349
	M8 / L = 40	5 nf	high-grade st. steel	10...30	IP67	700	100	33	IE5350
M12 connector · Output function  · DC PNP · Wiring diagram no. 2									
	M8 / L = 53	1 f	brass	10...36	IP67	750	200	35	IE5090
	M8 / L = 62	2 f	brass	10...36	IP67	1000	250	36	IE5312
	M8 / L = 50	2 f	high-grade st. steel	10...36	IP68	1000	100	37	IE5379
	M8 / L = 62	4 nf	brass	10...36	IP67	300	200	38	IE5288
M12 connector · Output function  · DC PNP · Wiring diagram no. 4									
	M8 / L = 62	2 f	brass	10...36	IP67	800	250	39	IE5327
M12 connector · Output function  · DC PNP/NPN · Wiring diagram no. 30									
	M8 / L = 69	1 f	brass	5...36	IP67	2700	200	40	IE5203
Cable 2 m · Output function  · DC PNP · Wiring diagram no. 1									
	M12 / L = 35	2 f	brass	10...36	IP67	1500	150	41	IF5188
	M12 / L = 71	2 f	brass	10...55	IP67	800	250	42	IF5297
	M12 / L = 71	2 f	PBT	10...55	IP67	800	250	42	IF5313
	M12 / L = 35	4 nf	brass	10...36	IP67	1500	150	43	IF5249
	M12 / L = 71	4 nf	brass	10...36	IP67	1500	250	44	IF5329
	M12 / L = 71	4 nf	PBT	10...36	IP67	400	250	42	IF5345





















Type	Dimensions [mm]	Sensing range [mm]	Material	U _b [V]	Protection	f [Hz]	I _{load} [mA]	Drawing no.	Order no.
Cable 2 m · Output function  · DC PNP/NPN · Wiring diagram no. 26									
	M12 / L = 71	2 f	brass	10...55	IP67	1100	400	42	IF5645
	M12 / L = 71	2 f	PBT	10...55	IP67	1100	400	42	IF5644
	M12 / L = 71	4 nf	brass	10...55	IP67	1500	400	44	IF5646
	M12 / L = 71	4 nf	PBT	10...55	IP67	1500	400	42	IF5597
M12 connector · Output function  · DC PNP/NPN · Wiring diagram no. 30									
	M12 / L = 83	2 f	brass	10...55	IP67	1100	300	45	IF5598
	M12 / L = 83	4 nf	brass	10...55	IP67	1500	300	46	IF5647
Cable 2 m · Output function  · DC PNP · Wiring diagram no. 1									
	M18 / L = 38	5 f	brass	18...36	IP67	500	150	47	IG5221
	M18 / L = 80	5 f	brass	10...36	IP67	500	250	48	IG5397
	M18 / L = 80	5 f	PBT	10...36	IP67	500	250	48	IG5399
	M18 / L = 38	8 nf	brass	18...36	IP67	200	150	49	IG5285
	M18 / L = 80	8 nf	brass	10...36	IP67	300	250	50	IG5398
	M18 / L = 80	8 nf	PBT	10...36	IP67	300	250	48	IG5401
Cable 2 m · Output function  · DC PNP/NPN · Wiring diagram no. 26									
	M18 / L = 80	5 f	PBT	10...55	IP67	700	400	48	IG5593
	M18 / L = 80	5 f	brass	10...55	IP67	700	400	48	IG5594























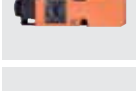

Inductive sensors

Type	Dimensions [mm]	Sensing range [mm]	Material	U _b [V]	Protection	f [Hz]	I _{load} [mA]	Draw- ing no.	Order no.
Table 2 m · Output function  /  · DC PNP/NPN · Wiring diagram no. 26									
	M18 / L = 80	8 nf	PBT	10...55	IP67	300	400	48	IG5533
	M18 / L = 80	8 nf	brass	10...55	IP67	300	400	50	IG5596
M12 connector · Output function  /  · DC PNP/NPN · Wiring diagram no. 30									
	M18 / L = 70	5 f	brass	10...55	IP67	700	400	51	IG5595
	M18 / L = 76	8 nf	brass	10...55	IP67	300	400	58	IG5597
Terminals · Output function  /  · DC PNP/NPN · Wiring diagram no. 31									
	M18 / L = 110	5 f	PBT	10...55	IP65	800	400	57	IG5718
	M18 / L = 110	8 nf	PBT	10...55	IP65	300	400	57	IG5719
Table 2 m · Output function  · DC PNP · Wiring diagram no. 1									
	Ø 20 / L = 77	10 nf	PBT	10...36	IP67	300	250	52	IA5082
Table 2 m · Output function  /  · DC PNP/NPN · Wiring diagram no. 26									
	Ø 20 / L = 77	10 nf	PBT	10...55	IP67	300	400	52	IA5108
M12 connector · Output function  · DC PNP · Wiring diagram no. 2									
	Ø 20 / L = 93	10 nf	PBT	10...36	IP67	300	250	53	IA5127
Terminals · Output function  · DC PNP · Wiring diagram no. 5									
	Ø 20 / L = 92	10 nf	PBT	10...36	IP65	300	250	54	IA5062
Terminals · Output function  · DC PNP · Wiring diagram no. 5									
	Ø 20 / L = 92	10 nf	PBT	10...36	IP65	300	250	54	IA5063
Terminals · Output function  /  · DC PNP/NPN · Wiring diagram no. 31									
	Ø 20 / L = 92	10 nf	PBT	10...55	IP65	300	300	54	IA5122
Table 2 m · Output function  · DC PNP · Wiring diagram no. 1									
	M30 / L = 45	10 f	brass	18...36	IP67	300	150	60	I15166

Type	Dimensions [mm]	Sensing range [mm]	Material	U _b [V]	Protection	f [Hz]	I _{load} [mA]	Drawing no.	Order no.
Cable 2 m · Output function  · DC PNP · Wiring diagram no. 1									
	M30 / L = 81	10 f	brass	10...36	IP67	250	250	59	I15256
	M30 / L = 81	10 f	PBT	10...36	IP67	250	250	59	I15369
	M30 / L = 45	15 nf	brass	18...36	IP67	250	150	61	I15346
	M30 / L = 81	15 nf	brass	10...36	IP67	250	250	62	I15284
	M30 / L = 81	15 nf	PBT	10...36	IP67	250	250	59	I15300
Cable 2 m · Output function  · DC PNP/NPN · Wiring diagram no. 26									
	M30 / L = 45	10 f	brass	10...55	IP67	450	400	60	I15493
	M30 / L = 81	10 f	PBT	10...55	IP67	450	400	59	I15488
	M30 / L = 81	10 f	brass	10...55	IP67	450	400	59	I15489
	M30 / L = 81	15 nf	PBT	10...55	IP67	200	400	59	I15436
	M30 / L = 81	15 nf	brass	10...55	IP67	200	400	62	I15491
M12 connector · Output function  · DC PNP/NPN · Wiring diagram no. 30									
	M30 / L = 78	10 f	brass	10...55	IP67	450	400	63	I15490
	M30 / L = 78	15 nf	brass	10...55	IP67	200	400	64	I15492
Cable 2 m · Output function  · DC PNP · Wiring diagram no. 1									
	∅ 34 / L = 82	20 nf	PBT	10...36	IP67	60	250	55	I15096
Terminals · Output function  · DC PNP/NPN · Wiring diagram no. 31									
	∅ 34 / L = 98	20 nf	PBT	10...55	IP65	300	300	56	I15124

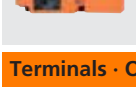
Inductive sensors

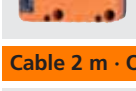
Type	Dimensions [mm]	Sensing range [mm]	Material	U _b [V]	Protection	f [Hz]	I _{load} [mA]	Draw- ing no.	Order no.
Terminals · Output function  · DC PNP · Wiring diagram no. 5									
	Ø 34 / L = 98	20 nf	PBT	10...36	IP65	350	250	56	IB5063
	Ø 34 / L = 98	30 nf	PBT	10...36	IP65	350	200	56	IB5133
Cable 2 m · Output function  · DC PNP · Wiring diagram no. 1									
	25 x 5 x 5	0.8 f	aluminium	10...30	IP65	1000	100	78	IL5022
	40 x 8 x 8	2 f	brass	10...36	IP65	2000	250	65	IL5002
	40 x 8 x 8	2 f	brass	10...36	IP65	2000	250	65	IL5003
	40 x 8 x 8	2.5 f	brass	10...36	IP65	2000	250	65	IL5020
M8 connector · Output function  · DC PNP · Wiring diagram no. 2									
	40 x 8 x 8	2 f	brass	10...36	IP65	2000	250	66	IL5004
	40 x 8 x 8	2 f	brass	10...36	IP65	2000	250	66	IL5005
Cable 2 m · Output function  · DC PNP · Wiring diagram no. 1									
	28 x 10 x 16	2 f	PBT	10...36	IP67	800	200	67	IS5001
	28 x 10 x 16	3 nf	PBT	10...36	IP67	100	200	67	IS5031
	28 x 10 x 16	4 nf	PBT	10...36	IP67	2000	250	77	IS5070
Cable 2 m · Output function  · DC PNP/NPN · Wiring diagram no. 26									
	28 x 10 x 16	2 f	PBT	5...36	IP67	2000	200	67	IS5026
M8 connector · Output function  · DC PNP · Wiring diagram no. 2									
	28 x 10 x 16	2 f	PBT	10...36	IP67	800	200	68	IS5035
	28 x 10 x 16	4 nf	PBT	10...36	IP67	2000	250	68	IS5071
Cable 2 m · Output function  · DC PNP · Wiring diagram no. 1									
	40 x 12 x 26	2 f	PBT	10...36	IP67	1400	250	69	IN5121
	40 x 12 x 26	4 nf	PBT	10...36	IP67	1300	250	69	IN5129
Cable 2 m · Output function  · DC PNP/NPN · Wiring diagram no. 26									
	40 x 12 x 26	2 f	PBT	10...55	IP67	1300	400	69	IN5207
	40 x 12 x 26	4 nf	PBT	10...55	IP67	1200	400	69	IN5208

Type	Dimensions [mm]	Sensing range [mm]	Material	U _b [V]	Protection	f [Hz]	I _{load} [mA]	Drawing no.	Order no.
Cable 2 m · Output function  · DC PNP · Wiring diagram no. 6									
	40 x 12 x 26	2 f	PBT	10...36	IP67	1400	250	69	IN5186
	40 x 12 x 26	4 nf	PBT	10...36	IP67	1300	250	69	IN5188
M8 connector · Output function  · DC PNP · Wiring diagram no. 2									
	40 x 12 x 26	2 f	PBT	10...36	IP67	1400	250	70	IN5230
	40 x 12 x 26	4 nf	PBT	10...36	IP65	1300	250	70	IN5212
Cable 2 m · Output function  · DC PNP · Wiring diagram no. 1									
	60 x 36 x 10	5 f	PBT	10...36	IP67	400	250	71	IW5051
	60 x 36 x 10	8 nf	PBT	10...36	IP67	300	250	79	IW5058
Cable 2 m · Output function  · DC PNP · Wiring diagram no. 6									
	60 x 36 x 10	5 f	PBT	10...36	IP67	400	250	71	IW5048
	60 x 36 x 10	8 nf	PBT	10...36	IP67	300	250	71	IW5053
M8 connector · Output function  · DC PNP · Wiring diagram no. 2									
	60 x 36 x 10	8 nf	PBT	10...36	IP65	300	250	80	IW5064
M8 connector · Output function  · DC PNP · Wiring diagram no. 3									
	60 x 36 x 10	8 nf	PBT	10...36	IP67	300	250	80	IW5062
Terminals · Output function  /  · DC PNP · Wiring diagram no. 5									
	40 x 40 x 120	15 f	PPE	10...36	IP65	350	250	72	IM5020
	40 x 40 x 120	20 nf	PPE	10...36	IP65	350	250	72	IM5019
	40 x 40 x 120	30 nf	PPE	10...36	IP65	100	250	72	IM5046
Terminals · Output function  /  · DC PNP/NPN · Wiring diagram no. 31									
	40 x 40 x 120	15 f	PPE	10...55	IP65	> 350	400	72	IM5037
	40 x 40 x 120	20 nf	PPE	10...55	IP65	> 300	400	72	IM5038
Terminals · Output function  +  · DC PNP · Wiring diagram no. 7									
	40 x 40 x 118	15 f	PBT	10...60	IP67	150	200	81	IV5003
	40 x 40 x 118	20 f	PBT	10...60	IP67	150	200	73	IV5004
Terminals · Output function  /  · DC PNP · Wiring diagram no. 32									
	90 x 60 x 40	40 nf	PPE	10...36	IP65	15	250	74	IC5005
Cable 2 m · Output function  · DC PNP · Wiring diagram no. 1									
	120 x 80 x 30	50 nf	PPE	10...36	IP67	100	250	75	ID5026

Inductive sensors

Type	Dimensions [mm]	Sensing range [mm]	Material	U _b [V]	Protection	f [Hz]	I _{load} [mA]	Draw- ing no.	Order no.
------	--------------------	--------------------------	----------	-----------------------	------------	-----------	---------------------------	---------------------	--------------

Terminals · Output function / · DC PNP · Wiring diagram no. 32

	105 x 80 x 40	60 nf	PPE	10...36	IP65	100	250	76	ID5005
-----------------------------------------------------------------------------------	---------------	-------	-----	---------	------	-----	-----	----	--------

f = flush / nf = non flush

Sensors for industrial applications, AC and AC/DC

Type	Dimensions [mm]	Sensing range [mm]	Material	U _b [V]	Protection	f AC / DC [Hz]	I _{load} AC / DC [mA]	Draw- ing no.	Order no.
------	--------------------	--------------------------	----------	-----------------------	------------	----------------------	--------------------------------------	---------------------	--------------

Table 2 m · Output function · AC · Wiring diagram no. 8





	M12 / L = 71	2 f	PBT	20...250	IP67	25	250	42	IF0001*
	M12 / L = 71	2 f	brass	20...250	IP67	25	250	42	IF0005*
	M12 / L = 71	4 nf	PBT	20...250	IP67	25	250	42	IF0003*
	M12 / L = 71	4 nf	brass	20...250	IP67	25	250	44	IF0007*

Table 2 m · Output function · AC/DC · Wiring diagram no. 9

























	M18 / L = 80	5 f	PBT	20...250	IP67	25 / 50	350 / 100	48	IG0005*
	M18 / L = 80	5 f	brass	20...250	IP67	25 / 50	350 / 100	48	IG0011*
	M18 / L = 80	8 nf	PBT	20...250	IP67	25 / 50	350 / 100	48	IG0006*
	M18 / L = 80	8 nf	brass	20...250	IP67	25 / 50	350 / 100	50	IG0012*
	∅ 20 / L = 77	10 nf	PBT	20...250	IP67	25 / 70	350 / 100	52	IA0004*

Table 2 m · Output function · AC/DC · Wiring diagram no. 10

	∅ 20 / L = 77	10 nf	PBT	20...250	IP67	25 / 70	350 / 100	52	IA0027*
-------------------------------------------------------------------------------------	---------------	-------	-----	----------	------	---------	-----------	----	---------

Terminals · Output function / · AC/DC · Wiring diagram no. 11

	∅ 20 / L = 92	10 nf	PBT	20...250	IP65	25 / 70	350 / 100	54	IA0032*
-------------------------------------------------------------------------------------	---------------	-------	-----	----------	------	---------	-----------	----	---------

Type	Dimensions [mm]	Sensing range [mm]	Material	U _b [V]	Protection	f AC / DC [Hz]	I _{load} AC / DC [mA]	Drawing no.	Order no.
Cable 2 m · Output function  · AC/DC · Wiring diagram no. 9									
	M30 / L = 81	10 f	PBT	20...250	IP67	25 / 50	350 / 100	59	II0005*
	M30 / L = 81	10 f	brass	20...250	IP67	25 / 50	350 / 100	59	II0011*
	M30 / L = 81	15 nf	PBT	20...250	IP67	25 / 50	350 / 100	59	II0006*
	M30 / L = 81	15 nf	brass	20...250	IP67	25 / 50	350 / 100	62	II0012*
	∅ 34 / L = 82	20 nf	PBT	20...250	IP67	25 / 50	350 / 100	55	IB0004*
	∅ 34 / L = 82	30 nf	PBT	20...250	IP67	25 / 50	350 / 100	55	IB0026*
Cable 2 m · Output function  · AC/DC · Wiring diagram no. 10									
	∅ 34 / L = 82	20 nf	PBT	20...250	IP67	25 / 50	350 / 100	55	IB0017*
	∅ 34 / L = 82	30 nf	PBT	20...250	IP67	25 / 50	350 / 100	55	IB0027*
Terminals · Output function  /  · AC/DC · Wiring diagram no. 11									
	∅ 34 / L = 98	20 nf	PBT	20...250	IP65	25 / 50	350 / 100	56	IB0016*
Cable 2 m · Output function  · AC/DC · Wiring diagram no. 9									
	40 x 12 x 26	2 f	PBT	20...250	IP67	25 / 50	350 / 100	69	IN0073*
	40 x 12 x 26	4 nf	PBT	20...250	IP67	25 / 50	350 / 100	69	IN0081*
Cable 2 m · Output function  · AC/DC · Wiring diagram no. 10									
	40 x 12 x 26	2 f	PBT	20...250	IP67	25 / 50	350 / 100	69	IN0077*
	40 x 12 x 26	4 nf	PBT	20...250	IP67	25 / 50	350 / 100	69	IN0085*
Terminals · Output function  /  · AC/DC · Wiring diagram no. 11									
	40 x 40 x 120	15 f	PPE	20...250	IP65	20 / 55	350 / 100	72	IM0011*
	40 x 40 x 120	20 nf	PPE	20...250	IP65	20 / 55	350 / 100	72	IM0010*
1/2" connector · Output function  · AC/DC · Wiring diagram no. 12									
	40 x 40 x 66	35 nf	PPE	20...250	IP67	20 / 50	350 / 100	82	IM0049*
M12 connector · Output function  · AC/DC · Wiring diagram no. 12									
	40 x 40 x 66	20 f	PPE	20...250	IP67	25 / 140	350 / 100	83	IM0054*
	40 x 40 x 66	35 nf	PPE	20...250	IP67	20 / 50	350 / 100	83	IM0053*

Inductive sensors

Type	Dimensions [mm]	Sensing range [mm]	Material	U _b [V]	Protection	f AC / DC [Hz]	I _{load} AC / DC [mA]	Draw- ing no.	Order no.
------	--------------------	--------------------------	----------	-----------------------	------------	----------------------	--------------------------------------	---------------------	--------------

Terminals · Output function / · AC/DC · Wiring diagram no. 33

	90 x 60 x 40	40 nf	PPE	20...250	IP65	10	350 / 100	74	IC0003*
-----------------------------------------------------------------------------------	--------------	-------	-----	----------	------	----	-----------	----	---------

Cable 2 m · Output function · AC/DC · Wiring diagram no. 9

	120 x 80 x 30	50 nf	modified PPE	20...250	IP65	25 / 35	350 / 100	75	ID0014*
-----------------------------------------------------------------------------------	---------------	-------	--------------	----------	------	---------	-----------	----	---------

M12 connector · Output function · AC/DC · Wiring diagram no. 12

	92 x 80 x 40	50 f	modified PPE	20...250	IP67	25	350 / 100	84	ID0049*
-----------------------------------------------------------------------------------	--------------	------	--------------	----------	------	----	-----------	----	---------

Terminals · Output function / · AC/DC · Wiring diagram no. 33

	105 x 80 x 40	60 nf	modified PPE	20...250	IP65	4	350 / 100	76	ID0013*
-----------------------------------------------------------------------------------	---------------	-------	--------------	----------	------	---	-----------	----	---------

f = flush / nf = non flush



* Note for AC and AC/DC units

Miniature fuse to IEC60127-2 sheet 1, ≤ 2 A (fast acting). Recommendation: check the unit for reliable function after a short circuit.





Sensors with increased sensing range for industrial automation





















Type	Dimensions [mm]	Sensing range [mm]	Material	U _b [V]	Protection	f [Hz]	I _{load} [mA]	Draw- ing no.	Order no.
------	--------------------	--------------------------	----------	-----------------------	------------	-----------	---------------------------	---------------------	--------------

M8 connector · Output function · DC PNP · Wiring diagram no. 2





















	M12 / L = 46	4 f	brass	10...36	IP67	700	100	85	IFS210
	M12 / L = 51	7 nf	brass	10...36	IP67	700	100	86	IFS211



















M12 connector · Output function · DC PNP · Wiring diagram no. 2

	M12 / L = 45	4 f	brass	10...36	IP67	700	100	87	IFS204
	M12 / L = 50	7 nf	brass	10...36	IP67	700	100	88	IFS205
	M12 / L = 70	4 f	brass	10...36	IP67	700	100	89	IFS212
	M12 / L = 70	7 nf	brass	10...36	IP67	700	100	90	IFS213

Type	Dimensions [mm]	Sensing range [mm]	Material	U _b [V]	Protection	f [Hz]	I _{load} [mA]	Drawing no.	Order no.
M12 connector · Output function  · DC PNP · Wiring diagram no. 4									
	M12 / L = 45	4 f	brass	10...36	IP67	700	100	87	IFS206
	M12 / L = 50	7 nf	brass	10...36	IP67	700	100	88	IFS207
M12 connector · Output function  · 3-wire DC PNP; 2-wire DC PNP/NPN · Wiring diagram no. 28									
	M12 / L = 70	4 f	brass	10...30	IP67	500	100	89	IFS208
	M12 / L = 70	7 nf	brass	10...30	IP67	500	100	90	IFS209
M12 connector · Output function  · DC PNP/NPN · Wiring diagram no. 34									
	M12 / L = 45	4 f	brass	10...30	IP67	700	100	87	IFS200
	M12 / L = 50	7 nf	brass	10...30	IP67	700	100	88	IFS201
M8 connector · Output function  · DC PNP · Wiring diagram no. 2									
	M18 / L = 46	8 f	brass	10...36	IP67	400	100	91	IGS210
	M18 / L = 52	12 nf	brass	10...36	IP67	400	100	92	IGS211
M12 connector · Output function  · DC PNP · Wiring diagram no. 2									
	M18 / L = 46	8 f	brass	10...36	IP67	400	100	93	IGS204
	M18 / L = 51	12 nf	brass	10...36	IP67	300	100	94	IGS205
	M18 / L = 70	8 f	brass	10...36	IP67	400	100	95	IGS212
	M18 / L = 70	12 nf	brass	10...36	IP67	300	100	96	IGS213
M12 connector · Output function  · DC PNP · Wiring diagram no. 4									
	M18 / L = 46	8 f	brass	10...36	IP67	400	100	93	IGS206
	M18 / L = 51	12 nf	brass	10...36	IP67	300	100	94	IGS207













Inductive sensors

Type	Dimensions [mm]	Sensing range [mm]	Material	U _b [V]	Protection	f [Hz]	I _{load} [mA]	Draw- ing no.	Order no.
M12 connector · Output function  · 3-wire DC PNP; 2-wire DC PNP/NPN · Wiring diagram no. 28									
	M18 / L = 70	8 f	brass	10...30	IP67	400	100	95	IGS208
	M18 / L = 70	12 nf	brass	10...30	IP67	300	100	96	IGS209
M12 connector · Output function  · DC PNP/NPN · Wiring diagram no. 34									
	M18 / L = 46	8 f	brass	10...30	IP67	300	100	93	IGS200
	M18 / L = 51	12 nf	brass	10...30	IP67	250	100	94	IGS201
M12 connector · Output function  · DC PNP · Wiring diagram no. 2									
	M30 / L = 50	15 f	brass	10...36	IP67	100	100	97	IIS204
	M30 / L = 50	22 nf	brass	10...36	IP67	100	100	98	IIS205
	M30 / L = 70	15 f	high-grade st. steel	10...36	IP67	100	100	99	IIS210
	M30 / L = 70	22 nf	high-grade st. steel	10...36	IP67	100	100	100	IIS211
M12 connector · Output function  · DC PNP · Wiring diagram no. 4									
	M30 / L = 50	15 f	brass	10...36	IP67	100	100	97	IIS208
	M30 / L = 50	22 nf	brass	10...36	IP67	100	100	98	IIS209
M12 connector · Output function  · 3-wire DC PNP; 2-wire DC PNP/NPN · Wiring diagram no. 28									
	M30 / L = 70	15 f	brass	10...30	IP67	100	100	99	IIS206
	M30 / L = 70	22 nf	brass	10...30	IP67	100	100	100	IIS207
M12 connector · Output function  · DC PNP · Wiring diagram no. 2									
	40 x 40 x 54	20 f	PA (polyamide)	10...36	IP67	100	200	101	IMS115
	40 x 40 x 54	20 f	PA (polyamide)	10...36	IP67	200	200	101	IMS128
	40 x 40 x 54	20 f	PA (polyamide)	10...36	IP67	200	200	102	IMS119

Type	Dimensions [mm]	Sensing range [mm]	Material	U _b [V]	Protection	f [Hz]	I _{load} [mA]	Drawing no.	Order no.
M12 connector · Output function  · DC PNP · Wiring diagram no. 2									
	40 x 40 x 54	35 nf	PA (polyamide)	10...36	IP67	80	200	101	IM5116
	40 x 40 x 54	35 nf	PA (polyamide)	10...36	IP67	200	200	101	IM5130
	40 x 40 x 54	35 nf	PA (polyamide)	10...36	IP67	200	200	102	IM5120
	40 x 40 x 54	40 nf	PA (polyamide)	10...36	IP67	60	200	101	IM5117
	40 x 40 x 54	40 nf	PA (polyamide)	10...36	IP67	200	200	101	IM5131
	40 x 40 x 54	40 nf	PA (polyamide)	10...36	IP67	200	200	102	IM5129
M12 connector · Output function  · DC PNP · Wiring diagram no. 13									
	40 x 40 x 54	20 f	PA (polyamide)	10...36	IP67	100	200	101	IM5123
	40 x 40 x 54	20 f	PA (polyamide)	10...36	IP67	200	200	101	IM5132
	40 x 40 x 54	20 f	PA (polyamide)	10...36	IP67	200	200	102	IM5124
	40 x 40 x 54	35 nf	PA (polyamide)	10...36	IP67	80	200	101	IM5134
	40 x 40 x 54	35 nf	PA (polyamide)	10...36	IP67	200	200	101	IM5133
	40 x 40 x 54	35 nf	PA (polyamide)	10...36	IP67	200	200	102	IM5125
	40 x 40 x 54	40 nf	PA (polyamide)	10...36	IP67	60	200	101	IM5136
	40 x 40 x 54	40 nf	PA (polyamide)	10...36	IP67 / IP69K	200	200	101	IM5135
	40 x 40 x 54	40 nf	PA (polyamide)	10...36	IP67	200	200	102	IM5126
M12 connector · AS-i · Wiring diagram no. 14									
	40 x 40 x 54	15 f	PBT	26.5...31.6	IP67	100	-	101	IM5118
M12 connector · Output function  · DC PNP · Wiring diagram no. 2									
	92 x 80 x 40	50 f	PPE	10...36	IP67	70	250	84	ID5055
M12 connector · Output function  · DC PNP · Wiring diagram no. 13									
	92 x 80 x 40	50 f	PPE	10...36	IP67	70	250	84	ID5058
M12 connector · Output function normally open / closed programmable *) · DC PNP · Wiring diagram no. 2									
	105 x 80 x 40	60 nf	PPE	10...36	IP65	100	250	103	ID5046

f = flush / nf = non flush







Sensors with increased shock and vibration resistance

Type	Dimensions [mm]	Sensing range [mm]	Material	U _b [V]	Protection	f [Hz]	I _{load} [mA]	Draw- ing no.	Order no.
M12 connector · Output function  · DC PNP · Wiring diagram no. 2									
	M12 / L = 45	2 f	brass	10...36	IP67	700	100	87	IFS214
	M12 / L = 70	2 f	brass	10...36	IP67	700	100	89	IFS216
	M12 / L = 50	4 nf	brass	10...36	IP67	700	100	88	IFS215
	M12 / L = 70	4 nf	brass	10...36	IP67	700	100	90	IFS217
	M18 / L = 46	5 f	brass	10...36	IP67	400	100	93	IGS214
	M18 / L = 70	5 f	brass	10...36	IP67	400	100	95	IGS216
	M18 / L = 51	8 nf	brass	10...36	IP67	300	100	94	IGS215
	M18 / L = 70	8 nf	brass	10...36	IP67	300	100	96	IGS217
	M30 / L = 50	10 f	high-grade st. steel	10...36	IP67	100	100	97	IIS212
	M30 / L = 70	10 f	high-grade st. steel	10...36	IP67	100	100	99	IIS214
	M30 / L = 50	15 nf	high-grade st. steel	10...36	IP67	100	100	98	IIS213
	M30 / L = 70	15 nf	high-grade st. steel	10...36	IP67	100	100	100	IIS215

f = flush / nf = non flush



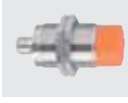



Sensors with analogue output 4...20 mA

Type	Dimensions [mm]	Sensing range [mm]	Material	U _b [V]	Protection	f [Hz]	I _{load} [mA]	Draw- ing no.	Order no.
M12 connector · Output function 4...20 mA analogue · DC analogue · Wiring diagram no. 15									
	M12 / L = 70	0.2...2 f	brass	15...30	IP67	–	–	89	IF6028

Type	Dimensions [mm]	Sensing range [mm]	Material	U _b [V]	Protection	f [Hz]	I _{load} [mA]	Draw- ing no.	Order no.
M12 connector · Output function 4...20 mA analogue · DC analogue · Wiring diagram no. 15									
	M12 / L = 70	0.4...4 nf	brass	15...30	IP67	–	–	90	IF6030
	M18 / L = 60	0.5...5 f	brass	15...30	IP67	–	–	104	IG6086
	M18 / L = 60	0.8...8 nf	brass	15...30	IP67	–	–	105	IG6083
	M30 / L = 70	1.0...10 f	brass	15...30	IP67	–	–	99	I15916
	M30 / L = 70	1.0...15 nf	brass	15...30	IP67	–	–	100	I15913
	40 x 40 x 54	1...15 f	PA (polyamide)	15...30	IP67	–	–	101	IM5139
	40 x 40 x 54	1...26 nf	PA (polyamide)	15...30	IP67	–	–	101	IM5141

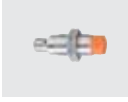

f = flush / nf = non flush

Sensors with analogue output 0...10 V

Type	Dimensions [mm]	Sensing range [mm]	Material	U _b [V]	Protection	f [Hz]	I _{load} [mA]	Draw- ing no.	Order no.
M12 connector · Output function 0...10 V analogue · DC analogue · Wiring diagram no. 15									
	M12 / L = 70	0.2...2 f	brass	15...30	IP67	–	–	89	IF6029
	M12 / L = 70	0.4...4 nf	brass	15...30	IP67	–	–	90	IF6031
	M18 / L = 60	0.5...5 f	brass	15...30	IP67	–	–	104	IG6087
	M18 / L = 60	0.8...8 nf	brass	15...30	IP67	–	–	105	IG6084
	M30 / L = 70	1.0...10 f	brass	15...30	IP67	–	–	99	I15917
	M30 / L = 70	1.0...15 nf	brass	15...30	IP67	–	–	100	I15914
	40 x 40 x 54	1...15 f	PA (polyamide)	15...30	IP67	–	–	101	IM5140
	40 x 40 x 54	1...26 nf	PA (polyamide)	15...30	IP67	–	–	101	IM5142



f = flush / nf = non flush





Photoelectric sensors

Type	Dimensions [mm]	Sensing range [mm]	Material	U _b [V]	Protection	f [Hz]	I _{load} [mA]	Drawing no.	Order no.
M12 connector · Output function  · DC PNP · Wiring diagram no. 2									
	M12 / L = 63	50 f	high-grade st. steel	10...30	IP68	1600	100	106	JAC201
	M12 / L = 63	50 f	high-grade st. steel	10...30	IP68 / IP69K	1600	100	106	JAT201

f = flush / nf = non flush



Full-metal sensors for oils and coolants

Type	Dimensions [mm]	Sensing range [mm]	Material	U _b [V]	Protection	f [Hz]	I _{load} [mA]	Drawing no.	Order no.
M8 connector · Output function  · DC PNP · Wiring diagram no. 2									
	M8 / L = 50	2 f	stainless steel	10...36	IP67	100	100	107	IEC201



M12 connector · Output function  · DC PNP · Wiring diagram no. 2									
	M8 / L = 60	2 f	high-grade st. steel	10...36	IP67 / IP68	100	100	108	IEC200
	M12 / L = 60	3 f	high-grade st. steel	10...36	IP67 / IP68	100	100	109	IFC258
	M18 / L = 70	5 f	high-grade st. steel	10...36	IP67 / IP68	100	100	51	IGC248
	M30 / L = 70	10 f	high-grade st. steel	10...36	IP67 / IP68	50	100	110	IIC224

























f = flush / nf = non flush

Sensors for oils and coolants

Type	Dimensions [mm]	Sensing range [mm]	Material	U _b [V]	Protection	f [Hz]	I _{load} [mA]	Drawing no.	Order no.
Cable 2 m · Output function  · DC PNP/NPN · Wiring diagram no. 35									
	M8 / L = 42	2 f	brass	10...55	IP67	1000	100	111	IE9203

Cable with connector 0.8 m · Output function  · DC PNP/NPN · Wiring diagram no. 16									
	M8 / L = 42	2 f	brass	10...55	IP67	1000	100	112	IE9902

M12 connector · Output function  · DC PNP/NPN · Wiring diagram no. 16									
	M8 / L = 69	1 f	brass	5...36	IP65	2000	200	40	IE9940

Type	Dimensions [mm]	Sensing range [mm]	Material	U _b [V]	Protection	f [Hz]	I _{load} [mA]	Drawing no.	Order no.
Cable 2 m · Output function  · DC PNP/NPN · Wiring diagram no. 35									
	M12 / L = 54	2 f	brass	10...55	IP67	800	100	113	IF9222
Cable with connector 0.8 m · Output function  · DC PNP/NPN · Wiring diagram no. 16									
	M12 / L = 54	2 f	brass	10...55	IP67	800	100	114	IF9920
M12 connector · Output function  · DC PNP/NPN · Wiring diagram no. 34									
	M12 / L = 45	4 f	brass	10...30	IP68	700	100	87	IFC200
	M12 / L = 50	7 nf	brass	10...30	IP68	700	100	88	IFC201
M12 connector · Output function  · DC PNP/NPN · Wiring diagram no. 36									
	M12 / L = 45	4 f	brass	10...30	IP68	700	100	87	IFC202
	M12 / L = 50	7 nf	brass	10...30	IP68	700	100	88	IFC203
M12 connector · Output function  /  · DC PNP/NPN · Wiring diagram no. 30									
	M12 / L = 60	7 nf	brass	10...36	IP68	500	100	115	IFC235
M12 connector · Output function  · DC PNP/NPN · Wiring diagram no. 16									
	M12 / L = 60	2 f	brass	10...55	IP67	800	100	116	IF9924
M12 connector · Output function  /  · DC · Wiring diagram no. 30									
	M12 / L = 60	4 f	brass	10...36	IP68	700	100	109	IFC234
Cable 2 m · Output function  · DC PNP/NPN · Wiring diagram no. 17									
	M18 / L = 54	5 f	brass	10...55	IP67	700	400	117	IG5682
Cable with connector 0.8 m · Output function  · DC PNP/NPN · Wiring diagram no. 16									
	M18 / L = 58	5 f	brass	10...55	IP67	700	400	118	IG9984
M12 connector · Output function  · DC PNP/NPN · Wiring diagram no. 34									
	M18 / L = 46	8 f	brass	10...30	IP68	400	100	93	IGC200

Inductive sensors

Type	Dimensions [mm]	Sensing range [mm]	Material	U _b [V]	Protection	f [Hz]	I _{load} [mA]	Draw- ing no.	Order no.
M12 connector · Output function  · DC PNP/NPN · Wiring diagram no. 34									
	M18 / L = 51	12 nf	brass	10...30	IP68	250	100	94	IGC201
M12 connector · Output function  · DC PNP/NPN · Wiring diagram no. 36									
	M18 / L = 46	8 f	brass	10...30	IP68	300	100	93	IGC202
	M18 / L = 51	12 nf	brass	10...30	IP68	250	100	94	IGC203
M12 connector · Output function  /  · DC PNP/NPN · Wiring diagram no. 30									
	M18 / L = 70	8 f	brass	10...30	IP68	400	100	95	IGC222
	M18 / L = 70	12 nf	brass	10...36	IP68	300	100	96	IGC223
M12 connector · Output function  · DC PNP/NPN · Wiring diagram no. 16									
	M18 / L = 65	5 f	brass	10...55	IP67	700	400	119	IG9983
M12 connector · Output function  /  · DC PNP/NPN · Wiring diagram no. 30									
	M30 / L = 70	15 f	brass	10...30	IP68	100	100	99	IIC208
	M30 / L = 70	22 nf	brass	10...30	IP68	100	100	100	IIC209
Cable with connector 0.8 m · Output function  · DC PNP/NPN · Wiring diagram no. 16									
	26 x 26 x 26	10 f	polyamide	10...36	IP67	250	100	120	IO5017
Cable with connector 0.15 m · Output function  · DC PNP/NPN · Wiring diagram no. 16									
	26 x 26 x 26	10 f	polyamide	10...36	IP67	250	100	120	IO5018
M12 connector · Output function  · DC PNP/NPN · Wiring diagram no. 16									
	26 x 26 x 43	10 f	polyamide	10...36	IP67	250	100	121	IO5016
Cable with connector 0.8 m · Output function  · DC PNP/NPN · Wiring diagram no. 37									
	40 x 40 x 66	15 f	PA (polyamide)	10...36	IP67	200	100	122	IM5137

Type	Dimensions [mm]	Sensing range [mm]	Material	U _b [V]	Protection	f [Hz]	I _{load} [mA]	Drawing no.	Order no.
------	-----------------	--------------------	----------	--------------------	------------	--------	------------------------	-------------	-----------

Cable with connector 0.8 m · Output function  · DC PNP/NPN · Wiring diagram no. 38

	40 x 40 x 66	15 f	PA (polyamide)	10...36	IP67	200	100	122	IM5138
-----------------------------------------------------------------------------------	--------------	------	----------------	---------	------	-----	-----	-----	--------

M12 connector · Output function  · DC PNP/NPN · Wiring diagram no. 38













	40 x 40 x 54	15 f	PA (polyamide)	10...36	IP67	200	100	123	IM5127
-----------------------------------------------------------------------------------	--------------	------	----------------	---------	------	-----	-----	-----	--------

f = flush / nf = non flush

















Sensors for oils and coolants with ceramic sensing face

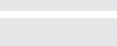
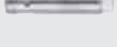





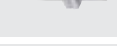
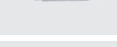
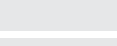







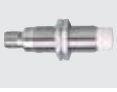



Type	Dimensions [mm]	Sensing range [mm]	Material	U _b [V]	Protection	f [Hz]	I _{load} [mA]	Drawing no.	Order no.
------	-----------------	--------------------	----------	--------------------	------------	--------	------------------------	-------------	-----------

M12 connector · Output function  · DC PNP · Wiring diagram no. 2



	M8 / L = 50	2 f	high-grade st. steel	10...36	IP67	1000	200	37	IE5381
	M8 / L = 50	4 nf	high-grade st. steel	10...36	IP67	700	200	124	IE5382
	M12 / L = 45	2 f	brass	10...36	IP68	700	200	87	IFC239
	M12 / L = 60	2 f	brass	10...36	IP68	700	200	109	IFC243
	M12 / L = 70	2 f	brass	10...36	IP68	700	200	89	IFC241
	M12 / L = 45	4 f	brass	10...36	IP68	700	100	87	IFC206
	M12 / L = 45	4 f	brass	10...36	IP68	700	100	87	IFC204
	M12 / L = 60	4 f	brass	10...36	IP68	700	200	109	IFC229
	M12 / L = 70	4 f	brass	10...36	IP68	700	100	89	IFC237
	M12 / L = 50	4 nf	brass	10...36	IP68	700	200	88	IFC240
	M12 / L = 60	4 nf	brass	10...36	IP68	700	200	115	IFC244
	M12 / L = 70	4 nf	brass	10...36	IP68	700	200	90	IFC242

Inductive sensors

Type	Dimensions [mm]	Sensing range [mm]	Material	U_b [V]	Protection	f [Hz]	I_{load} [mA]	Draw- ing no.	Order no.
M12 connector · Output function  · DC PNP · Wiring diagram no. 2									
	M12 / L = 50	7 nf	brass	10...36	IP68	700	100	88	IFC205
	M12 / L = 60	7 nf	brass	10...36	IP68	700	200	115	IFC230
	M12 / L = 70	7 nf	brass	10...36	IP68	700	100	90	IFC238
M12 connector · Output function  · 3-wire DC PNP; 2-wire DC PNP/NPN · Wiring diagram no. 28									
	M12 / L = 70	4 f	brass	10...30	IP68	500	100	89	IFC210
M12 connector · Output function  · DC PNP · Wiring diagram no. 4									
	M12 / L = 45	4 f	brass	10...36	IP68	700	100	87	IFC209
	M12 / L = 45	4 f	brass	10...36	IP68	700	100	87	IFC207
	M12 / L = 50	7 nf	brass	10...36	IP68	700	100	88	IFC208
M12 connector · Output function  · DC PNP · Wiring diagram no. 2									
	M18 / L = 46	5 f	brass	10...36	IP68	400	200	93	IGC226
	M18 / L = 60	5 f	brass	10...36	IP68	400	200	104	IGC230
	M18 / L = 70	5 f	brass	10...36	IP68	400	200	95	IGC228
	M18 / L = 46	8 f	brass	10...36	IP68	400	100	93	IGC206
	M18 / L = 46	8 f	brass	10...36	IP68	400	100	93	IGC204
	M18 / L = 60	8 f	brass	10...36	IP68	400	200	125	IGC221
	M18 / L = 51	8 nf	brass	10...36	IP68	300	200	94	IGC227
	M18 / L = 70	8 f	brass	10...36	IP68	400	100	95	IGC224
	M18 / L = 60	8 nf	brass	10...36	IP68	300	200	105	IGC231



Type	Dimensions [mm]	Sensing range [mm]	Material	U _b [V]	Protection	f [Hz]	I _{load} [mA]	Drawing no.	Order no.
M12 connector · Output function  · DC PNP · Wiring diagram no. 2									
	M18 / L = 70	8 nf	brass	10...36	IP68	300	200	96	IGC229
	M18 / L = 51	12 nf	brass	10...36	IP68	300	100	94	IGC205
	M18 / L = 60	12 nf	brass	10...36	IP68	300	200	105	IGC220
	M18 / L = 70	12 nf	brass	10...36	IP68	300	100	96	IGC225
M12 connector · Output function  · DC PNP · Wiring diagram no. 4									
	M18 / L = 46	8 f	brass	10...36	IP68	400	100	93	IGC209
	M18 / L = 51	12 nf	brass	10...36	IP68	300	100	94	IGC208
M12 connector · Output function  · 3-wire DC PNP; 2-wire DC PNP/NPN · Wiring diagram no. 28									
	M18 / L = 70	8 f	brass	10...30	IP68	400	100	95	IGC210
M12 connector · Output function  · DC PNP · Wiring diagram no. 2									
	M30 / L = 50	10 f	high-grade st. steel	10...36	IP68	100	200	97	IIC212
	M30 / L = 70	10 f	high-grade st. steel	10...36	IP68	100	200	99	IIC214
	M30 / L = 50	15 f	brass	10...36	IP68	100	100	97	IIC200
	M30 / L = 60	15 f	brass	10...36	IP68	100	200	126	IIC206
	M30 / L = 70	15 f	high-grade st. steel	10...36	IP68	100	100	99	IIC210
	M30 / L = 50	15 nf	high-grade st. steel	10...36	IP68	100	200	98	IIC213
	M30 / L = 60	15 nf	high-grade st. steel	10...36	IP68	100	200	127	IIC217
	M30 / L = 70	15 nf	high-grade st. steel	10...36	IP68	100	200	100	IIC215







Inductive sensors

Type	Dimensions [mm]	Sensing range [mm]	Material	U _b [V]	Protection	f [Hz]	I _{load} [mA]	Draw- ing no.	Order no.
M12 connector · Output function  · DC PNP · Wiring diagram no. 2									
	M30 / L = 50	22 nf	brass	10...36	IP68	100	100	98	IIC201
	M30 / L = 60	22 nf	brass	10...36	IP68	100	200	127	IIC207
	M30 / L = 70	22 nf	high-grade st. steel	10...36	IP68	100	100	100	IIC211

f = flush / nf = non flush



Sensors for oils and coolants with correction factor K = 1



Type	Dimensions [mm]	Sensing range [mm]	Material	U _b [V]	Protection	f [Hz]	I _{load} [mA]	Draw- ing no.	Order no.
M8 connector · Output function  · DC PNP · Wiring diagram no. 2									
	M8 / L = 65	1.5 f	high-grade st. steel	10...30	IP67	2000	200	128	IE5390
	M8 / L = 65	4 nf	high-grade st. steel	10...30	IP67	2000	200	129	IE5391

M12 connector · Output function  · DC PNP · Wiring diagram no. 2									
	M12 / L = 65	8 nf	high-grade st. steel	10...30	IP68	> 2000	200	130	IFC246
	M18 / L = 65	5 f	high-grade st. steel	10...30	IP68	> 2000	200	131	IGC232
	M18 / L = 65	12 nf	high-grade st. steel	10...30	IP68	> 2000	200	132	IGC233
	M30 / L = 65	10 f	high-grade st. steel	10...30	IP68	1000	200	133	IIC218
	M30 / L = 65	22 nf	high-grade st. steel	10...30	IP68	1000	200	134	IIC219

f = flush / nf = non flush







Sensors for oils and coolants for the detection of ferrous metals

Type	Dimensions [mm]	Sensing range [mm]	Material	U _b [V]	Protection	f [Hz]	I _{load} [mA]	Draw- ing no.	Order no.
M12 connector · Output function  · DC PNP · Wiring diagram no. 2									
	M12 / L = 60	2.5 f	stainless steel	10...36	IP68	100	100	109	IFC263
	M18 / L = 70	4.5 f	stainless steel	10...36	IP68	100	100	135	IGC249

Type	Dimensions [mm]	Sensing range [mm]	Material	U _b [V]	Protection	f [Hz]	I _{load} [mA]	Draw- ing no.	Order no.
M12 connector · Output function  · DC PNP · Wiring diagram no. 4									
	M12 / L = 60	2.5 f	stainless steel	10...36	IP68	100	100	109	IFC264
	M18 / L = 70	4.5 f	stainless steel	10...36	IP68	100	100	135	IGC250









f = flush / nf = non flush

Sensors for oils and coolants, AS-i system



















Type	Dimensions [mm]	Sensing range [mm]	Material	U _b [V]	Protection	f [Hz]	I _{load} [mA]	Draw- ing no.	Order no.
M12 connector · AS-i · Wiring diagram no. 14									
	M12 / L = 60	4 f	high-grade st. steel	26.5...31.6	IP68	100	–	109	IFC247
	M12 / L = 60	7 nf	high-grade st. steel	26.5...31.6	IP68	100	–	115	IFC248
	M18 / L = 60	8 f	high-grade st. steel	26.5...31.6	IP68	100	–	125	IGC234
	M18 / L = 60	12 nf	high-grade st. steel	26.5...31.6	IP68	100	–	105	IGC235
	M30 / L = 60	14 f	high-grade st. steel	26.5...31.6	IP68	100	–	126	IIC220
	M30 / L = 60	22 nf	high-grade st. steel	26.5...31.6	IP68	100	–	127	IIC221

f = flush / nf = non flush

Sensors for mobile applications





Type	Dimensions [mm]	Sensing range [mm]	Material	U _b [V]	Protection	f [Hz]	I _{load} [mA]	Draw- ing no.	Order no.
Cable 6 m · Output function  · DC PNP · Wiring diagram no. 1									
	M12 / L = 79	4 f	stainless steel	10...36	IP67 / IP69K	400	100	136	IFM207
	M12 / L = 79	4 f	stainless steel	10...60	IP67 / IP69K	400	200	136	IFM209
	M12 / L = 79	7 nf	stainless steel	10...36	IP67 / IP69K	300	100	137	IFM208
	M12 / L = 79	7 nf	high-grade st. steel	10...60	IP67 / IP69K	300	200	137	IFM210
M12 connector · Output function  · DC PNP · Wiring diagram no. 2									
	M12 / L = 70	4 f	high-grade st. steel	10...36	IP67 / IP69K	400	100	138	IFM203
	M12 / L = 70	4 f	high-grade st. steel	10...60	IP67 / IP69K	400	200	138	IFM205

Inductive sensors

Type	Dimensions [mm]	Sensing range [mm]	Material	U _b [V]	Protection	f [Hz]	I _{load} [mA]	Draw- ing no.	Order no.
M12 connector · Output function  · DC PNP · Wiring diagram no. 2									
	M12 / L = 70	7 nf	high-grade st. steel	10...36	IP67 / IP69K	300	100	139	IFM204
	M12 / L = 70	7 nf	stainless steel	10...60	IP67 / IP69K	300	200	139	IFM206
Cable 6 m · Output function  · DC PNP · Wiring diagram no. 1									
	M18 / L = 81	8 f	stainless steel	10...36	IP67 / IP69K	200	100	140	IGM202
	M18 / L = 81	8 f	stainless steel	10...60	IP67 / IP69K	200	200	140	IGM206
	M18 / L = 81	12 nf	stainless steel	10...36	IP67 / IP69K	200	100	141	IGM203
	M18 / L = 81	12 nf	stainless steel	10...60	IP67 / IP69K	200	200	141	IGM207
M12 connector · Output function  · DC PNP · Wiring diagram no. 2									
	M18 / L = 70	8 f	stainless steel	10...36	IP67 / IP69K	200	100	135	IGM200
	M18 / L = 70	8 f	stainless steel	10...60	IP67 / IP69K	200	200	135	IGM204
	M18 / L = 70	12 nf	stainless steel	10...36	IP67 / IP69K	200	100	142	IGM201
	M18 / L = 70	12 nf	stainless steel	10...60	IP67 / IP69K	200	200	142	IGM205
Cable 6 m · Output function  · DC PNP · Wiring diagram no. 1									
	M30 / L = 81	12 f	stainless steel	10...36	IP67 / IP69K	100	100	143	IIM202
	M30 / L = 81	12 f	stainless steel	10...60	IP67 / IP69K	100	200	143	IIM210
	M30 / L = 81	22 nf	stainless steel	10...36	IP67 / IP69K	100	100	144	IIM203
	M30 / L = 81	22 nf	stainless steel	10...60	IP67 / IP69K	100	200	144	IIM211
M12 connector · Output function  · DC PNP · Wiring diagram no. 2									
	M30 / L = 70	12 f	stainless steel	10...36	IP67 / IP69K	100	100	99	IIM200
	M30 / L = 70	12 f	stainless steel	10...60	IP67 / IP69K	100	200	99	IIM208
	M30 / L = 70	22 nf	stainless steel	10...36	IP67 / IP69K	100	100	100	IIM201
	M30 / L = 70	22 nf	stainless steel	10...60	IP67 / IP69K	100	200	100	IIM209
Cable 3 m · Output function  · DC PNP · Wiring diagram no. 18									
	40 x 12 x 26	4 nf	PBT	10...36	IP67	70	–	69	IN5281
Cable 3 m · Output function  · DC PNP · Wiring diagram no. 19									
	40 x 12 x 26	4 nf	PBT	10...36	IP67	70	–	69	IN5282











f = flush / nf = non flush

Full-metal sensors with non-stick coating against weld spatter



Type	Dimensions [mm]	Sensing range [mm]	Material	U _b [V]	Protection	f [Hz]	I _{load} [mA]	Draw- ing no.	Order no.
M12 connector · Output function  · DC PNP · Wiring diagram no. 2									
	M8 / L = 60	2 f	stainless steel	10...36	IP67 / IP68	100	100	108	IER200
	M12 / L = 60	4 f	high-grade st. steel	10...36	IP67	2	100	109	IFR200
	M18 / L = 70	6 f	high-grade st. steel	10...36	IP67	2	100	51	IGR200
	M30 / L = 70	12 f	high-grade st. steel	10...36	IP67	2	100	110	IIR200

f = flush / nf = non flush

Electromagnetic field immune sensors with correction factor K = 1









Type	Dimensions [mm]	Sensing range [mm]	Material	U _b [V]	Protection	f [Hz]	I _{load} [mA]	Draw- ing no.	Order no.
M12 connector · Output function  · DC PNP · Wiring diagram no. 2									
	M12 / L = 65	3 f	brass	10...30	IP67	4000	200	145	IFW200
	M12 / L = 65	8 nf	brass	10...30	IP67	4000	200	146	IFW201
	M18 / L = 65	5 f	brass	10...30	IP67	2000	200	131	IGW200
	M18 / L = 65	12 nf	brass	10...30	IP67	2000	200	132	IGW201
	M30 / L = 65	10 f	brass	10...30	IP67	1000	200	133	IIW200
	M30 / L = 65	22 nf	brass	10...30	IP67	1000	200	147	IIW201
	40 x 40 x 54	20 f	PA (polyamide)	10...36	IP67	200	200	102	IM5119
	40 x 40 x 54	35 nf	PA (polyamide)	10...36	IP67	200	200	102	IM5120
	40 x 40 x 54	40 nf	PA (polyamide)	10...36	IP67	200	200	102	IM5129
M12 connector · Output function  · DC PNP · Wiring diagram no. 13									
	40 x 40 x 54	20 f	PA (polyamide)	10...36	IP67	200	200	102	IM5124
	40 x 40 x 54	35 nf	PA (polyamide)	10...36	IP67	200	200	102	IM5125
	40 x 40 x 54	40 nf	PA (polyamide)	10...36	IP67	200	200	102	IM5126



Inductive sensors

Type	Dimensions [mm]	Sensing range [mm]	Material	U _b [V]	Protection	f [Hz]	I _{load} [mA]	Draw- ing no.	Order no.
M12 connector · Output function  · DC PNP · Wiring diagram no. 13									
	40 x 40 x 54	20 f	PA (polyamide)	10...36	IP67	200	200	101	IM5132
	40 x 40 x 54	35 nf	PA (polyamide)	10...36	IP67	200	200	101	IM5133
	40 x 40 x 54	40 nf	PA (polyamide)	10...36	IP67 / IP69K	200	200	101	IM5135

f = flush / nf = non flush

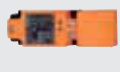

Electromagnetic field immune sensors

















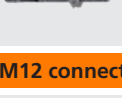

Type	Dimensions [mm]	Sensing range [mm]	Material	U _b [V]	Protection	f [Hz]	I _{load} [mA]	Draw- ing no.	Order no.
M12 connector · Output function  · DC PNP · Wiring diagram no. 2									
	M12 / L = 60	2 f	brass	10...36	IP67	1000	250	148	IF5670
	M12 / L = 60	2 f	brass	10...36	IP67	1000	250	148	IF5750
	M12 / L = 60	4 nf	brass	10...36	IP67	1000	250	149	IF5675
	M12 / L = 60	4 nf	brass	10...36	IP67	1000	250	149	IF5751
	M18 / L = 60	5 f	brass	10...36	IP67	700	250	104	IG5647
	M18 / L = 60	5 f	brass	10...36	IP67	700	250	104	IG5667
	M30 / L = 60	10 f	brass	10...36	IP67	250	250	150	II5503
	40 x 40 x 118	15 f	modified PPE	10...60	IP67	50	200	151	IV5025

M12 connector · Output function  · DC PNP · Wiring diagram no. 13									
	92 x 80 x 40	50 f	PPE	10...36	IP67	70	250	84	ID5059







f = flush / nf = non flush

Sensors for hygienic and wet areas

Type	Dimensions [mm]	Sensing range [mm]	Material	U _b [V]	Protection	f [Hz]	I _{load} [mA]	Draw- ing no.	Order no.
M12 connector · Output function  · DC PNP · Wiring diagram no. 2									
	M8 / L = 70	1 f	high-grade st. steel	10...36	IP67	2000	200	152	IE5215





Type	Dimensions [mm]	Sensing range [mm]	Material	U _b [V]	Protection	f [Hz]	I _{load} [mA]	Drawing no.	Order no.
M12 connector · Output function  · DC PNP · Wiring diagram no. 2									
	M8 / L = 55	2 nf	high-grade st. steel	10...36	IP67	2000	200	153	IE5295
	M12 / L = 44	2 f	high-grade st. steel	10...36	IP67	1200	250	154	IF5815
	M12 / L = 59	2 f	high-grade st. steel	10...36	IP67	1100	200	155	IF5514
	M12 / L = 83	2 f	high-grade st. steel	10...36	IP67	800	250	45	IF5851
	M12 / L = 44	4 nf	high-grade st. steel	10...36	IP67	1400	150	156	IF5796
	M12 / L = 59	4 nf	high-grade st. steel	10...36	IP67	1400	250	157	IF5813
	M12 / L = 83	4 nf	high-grade st. steel	10...36	IP67	400	250	46	IF5594
M12 connector · Output function  · DC PNP/NPN · Wiring diagram no. 30									
	M12 / L = 83	2 f	high-grade st. steel	10...55	IP67	1100	400	45	IF5759
	M12 / L = 83	4 nf	high-grade st. steel	10...55	IP67	1500	300	46	IF5760
Cable 2 m · Output function  · DC PNP · Wiring diagram no. 20									
	M18 / L = 80	8 nf	high-grade st. steel	10...36	IP67	320	250	50	IG5202
M12 connector · Output function  · DC PNP · Wiring diagram no. 2									
	M18 / L = 76	5 f	high-grade st. steel	10...36	IP67	500	250	158	IG5813
	M18 / L = 90	8 nf	high-grade st. steel	10...36	IP67	300	250	159	IG5602
M12 connector · Output function  · DC PNP/NPN · Wiring diagram no. 30									
	M18 / L = 90	5 f	high-grade st. steel	10...55	IP67	700	400	160	IG5806
	M18 / L = 77	8 nf	high-grade st. steel	10...55	IP67	300	300	161	IG5772

Inductive sensors

Type	Dimensions [mm]	Sensing range [mm]	Material	U _b [V]	Protection	f [Hz]	I _{load} [mA]	Draw- ing no.	Order no.
M12 connector · Output function  · DC PNP · Wiring diagram no. 2									
	M30 / L = 92	10 f	high-grade st. steel	10...36	IP67	250	250	162	I15689
	M30 / L = 92	15 nf	high-grade st. steel	10...36	IP67	200	250	163	I15776
M12 connector · Output function  · DC PNP/NPN · Wiring diagram no. 30									
	M30 / L = 92	10 f	high-grade st. steel	10...55	IP67	450	400	162	I15751
	M30 / L = 78	15 nf	high-grade st. steel	10...55	IP67	200	400	64	I15733





f = flush / nf = non flush





















Full-metal sensors for hygienic and wet areas

Type	Dimensions [mm]	Sensing range [mm]	Material	U _b [V]	Protection	f [Hz]	I _{load} [mA]	Draw- ing no.	Order no.
M12 connector · Output function  · DC PNP · Wiring diagram no. 2									
	M12 / L = 60	3 f	high-grade st. steel	10...36	IP68 / IP69K	100	100	164	IFT243
	M12 / L = 60	3 f	high-grade st. steel	10...36	IP68 / IP69K	100	100	109	IFT240
	M18 / L = 70	5 f	high-grade st. steel	10...36	IP68 / IP69K	100	100	51	IGT247
	M30 / L = 70	10 f	high-grade st. steel	10...36	IP68 / IP69K	50	100	110	IIT228





f = flush / nf = non flush















Sensors for hygienic and wet areas with increased sensing range

Type	Dimensions [mm]	Sensing range [mm]	Material	U _b [V]	Protection	f [Hz]	I _{load} [mA]	Draw- ing no.	Order no.
M12 connector · Output function  · DC PNP · Wiring diagram no. 2									
	M12 / L = 45	4 f	high-grade st. steel	10...36	IP68 / IP69K	800	100	87	IFT203
	M12 / L = 50	7 nf	high-grade st. steel	10...36	IP68 / IP69K	800	100	165	IFT200
	M12 / L = 70	4 f	high-grade st. steel	10...36	IP68 / IP69K	700	100	89	IFT216

Type	Dimensions [mm]	Sensing range [mm]	Material	U _b [V]	Protection	f [Hz]	I _{load} [mA]	Drawing no.	Order no.
M12 connector · Output function  · DC PNP · Wiring diagram no. 2									
	M12 / L = 70	7 nf	high-grade st. steel	10...36	IP68 / IP69K	800	100	90	IFT217
M12 connector · Output function  · DC PNP · Wiring diagram no. 4									
	M12 / L = 45	4 f	high-grade st. steel	10...36	IP68 / IP69K	800	100	87	IFT204
	M12 / L = 50	7 nf	high-grade st. steel	10...36	IP68 / IP69K	800	100	165	IFT201
M12 connector · Output function  · 3-wire DC PNP; 2-wire DC PNP/NPN · Wiring diagram no. 28									
	M12 / L = 70	4 f	high-grade st. steel	10...36	IP68 / IP69K	500	100	89	IFT205
	M12 / L = 70	7 nf	high-grade st. steel	10...30	IP68 / IP69K	700	100	139	IFT202
	∅ 12 / L = 70	7 nf	high-grade st. steel	10...30	IP68 / IP69K	700	100	166	IFT210
Cable 6 m · Output function  · DC PNP · Wiring diagram no. 1									
	M12 / L = 50	4 f	high-grade st. steel	10...36	IP68 / IP69K	800	100	167	IFT206
	M12 / L = 61	7 nf	high-grade st. steel	10...36	IP68 / IP69K	800	100	168	IFT208
Cable 6 m · Output function  · 3-wire DC PNP; 2-wire DC PNP/NPN · Wiring diagram no. 27									
	∅ 12 / L = 79	7 nf	high-grade st. steel	10...30	IP68 / IP69K	700	100	169	IFT211
Cable 10 m · Output function  · DC PNP · Wiring diagram no. 1									
	M12 / L = 56	4 f	high-grade st. steel	10...36	IP68 / IP69K	800	100	170	IFT207
	M12 / L = 61	7 nf	high-grade st. steel	10...36	IP68 / IP69K	800	100	168	IFT209
M12 connector · Output function  · DC PNP · Wiring diagram no. 2									
	M18 / L = 46	8 f	high-grade st. steel	10...36	IP68 / IP69K	600	100	93	IGT203
	M18 / L = 51	12 nf	high-grade st. steel	10...36	IP68 / IP69K	300	100	171	IGT200



Inductive sensors

Type	Dimensions [mm]	Sensing range [mm]	Material	U _b [V]	Protection	f [Hz]	I _{load} [mA]	Draw- ing no.	Order no.
M12 connector · Output function  · DC PNP · Wiring diagram no. 2									
	M18 / L = 70	8 f	high-grade st. steel	10...36	IP68 / IP69K	400	100	95	IGT219
	M18 / L = 70	12 nf	high-grade st. steel	10...36	IP68 / IP69K	300	100	96	IGT220
M12 connector · Output function  · DC PNP · Wiring diagram no. 4									
	M18 / L = 46	8 f	high-grade st. steel	10...36	IP68 / IP69K	600	100	93	IGT204
	M18 / L = 51	12 nf	high-grade st. steel	10...36	IP68 / IP69K	300	100	171	IGT201
M12 connector · Output function  · 3-wire DC PNP; 2-wire DC PNP/NPN · Wiring diagram no. 28									
	M18 / L = 70	8 f	high-grade st. steel	10...30	IP68 / IP69K	400	100	135	IGT205
	M18 / L = 70	12 nf	high-grade st. steel	10...30	IP68 / IP69K	300	100	172	IGT202
	Ø 18 / L = 70	12 nf	high-grade st. steel	10...30	IP68 / IP69K	300	100	173	IGT211
Cable 6 m · Output function  · DC PNP · Wiring diagram no. 1									
	M18 / L = 57	8 f	high-grade st. steel	10...36	IP68 / IP69K	600	100	174	IGT206
	M18 / L = 62	12 nf	high-grade st. steel	10...36	IP68 / IP69K	300	100	175	IGT208
Cable 6 m · Output function  · 3-wire DC PNP; 2-wire DC PNP/NPN · Wiring diagram no. 27									
	Ø 18 / L = 81	12 nf	high-grade st. steel	10...30	IP68 / IP69K	300	100	176	IGT212
Cable 10 m · Output function  · DC PNP · Wiring diagram no. 1									
	M18 / L = 57	8 f	high-grade st. steel	10...36	IP68 / IP69K	600	100	174	IGT207
	M18 / L = 60	12 nf	high-grade st. steel	10...36	IP68 / IP69K	300	100	177	IGT209
M12 connector · Output function  · DC PNP · Wiring diagram no. 2									
	M30 / L = 50	14 f	high-grade st. steel	10...36	IP68 / IP69K	50	100	97	IIT205

Type	Dimensions [mm]	Sensing range [mm]	Material	U _b [V]	Protection	f [Hz]	I _{load} [mA]	Drawing no.	Order no.
M12 connector · Output function  · DC PNP · Wiring diagram no. 2									
	M30 / L = 50	22 nf	high-grade st. steel	10...36	IP68 / IP69K	100	100	178	IIT200
	M30 / L = 70	15 f	high-grade st. steel	10...36	IP68 / IP69K	50	100	99	IIT212
	M30 / L = 70	22 nf	high-grade st. steel	10...36	IP68 / IP69K	100	100	100	IIT213
M12 connector · Output function  · 3-wire DC PNP; 2-wire DC PNP/NPN · Wiring diagram no. 28									
	M30 / L = 70	14 f	high-grade st. steel	10...36	IP68 / IP69K	50	100	99	IIT204
	M30 / L = 70	22 nf	high-grade st. steel	10...36	IP68 / IP69K	100	100	100	IIT202
1/2" connector · Output function  · AC/DC · Wiring diagram no. 21									
	M30 / L = 70	22 nf	high-grade st. steel	20...140	IP68 / IP69K	25 / 100	200	179	IIT002
Cable 6 m · Output function  · DC PNP · Wiring diagram no. 1									
	M30 / L = 59	22 nf	high-grade st. steel	10...36	IP68 / IP69K	100	100	180	IIT207
	M30 / L = 59	14 f	high-grade st. steel	10...36	IP68 / IP69K	100	100	181	IIT209
Cable 10 m · Output function  · DC PNP · Wiring diagram no. 1									
	M30 / L = 59	14 f	high-grade st. steel	10...36	IP68 / IP69K	100	100	181	IIT206
	M30 / L = 59	22 nf	high-grade st. steel	10...36	IP68 / IP69K	100	100	180	IIT208

f = flush / nf = non flush

Sensors with ATEX approval 1D / 2G



Type	Dimensions [mm]	Sensing range [mm]	Material	U _{nom.} at 1 KΩ [V]	U _b [V]	Internal capacit. [nF]	Internal inductance [μH]	f [Hz]	Drawing no.	Order no.
Cable 2 m · Output function  · Connection to certified intrinsically safe circuits with the max. values U = 15 V / I = 50 mA / P = 120 mW · Wiring diagram no. 22										
	Ø 6.5 / L = 30	1 f	brass	8.2 DC	7.5...30	80	70	2000	182	NT5001







Inductive sensors



Type	Dimensions [mm]	Sensing range [mm]	Material	U _{nom.} at 1 KΩ [V]	U _b [V]	Internal capacit. [nF]	Internal inductance [μH]	f [Hz]	Draw- ing no.	Order no.
Cable 2 m · Output function  · Connection to certified intrinsically safe circuits with the max. values U = 15 V / I = 50 mA / P = 120 mW · Wiring diagram no. 22										
	M8 / L = 30	1 f	brass	8.2 DC	7.5...30	80	70	2000	183	NE5001
	M12 / L = 30	2 f	PBT	8.2 DC	7.5...30	140	340	1200	184	NF5001
	M12 / L = 30	4 nf	PBT	8.2 DC	7.5...30	140	130	1500	184	NF5003
	M12 / L = 30	2 f	brass	8.2 DC	7.5...30	140	340	1200	184	NF5002
	M12 / L = 30	4 nf	brass	8.2 DC	7.5...30	140	130	1500	185	NF5004
	M18 / L = 33	5 f	PBT	8.2 DC	7.5...30	145	45	720	186	NG5001
	M18 / L = 33	8 nf	PBT	8.2 DC	7.5...30	155	50	300	186	NG5003
	M18 / L = 33	5 f	brass	8.2 DC	7.5...30	145	45	720	186	NG5002
	M18 / L = 33	8 nf	brass	8.2 DC	7.5...30	155	50	300	187	NG5004
	M30 / L = 41	10 f	PBT	8.2 DC	7.5...30	145	140	450	188	NI5001
	M30 / L = 41	15 nf	PBT	8.2 DC	7.5...30	145	110	200	188	NI5003
	M30 / L = 41	10 f	brass	8.2 DC	7.5...30	145	140	450	188	NI5002
	M30 / L = 41	15 nf	brass	8.2 DC	7.5...30	145	110	200	189	NI5004
	28 x 10 x 16	2 f	PBT	8.2 DC	7.5...30	80	110	800	190	NS5002
	40 x 12 x 26	2 f	PBT	8.2 DC	7.5...30	110	135	800	191	NN5001
	40 x 12 x 26	4 nf	PBT	8.2 DC	7.5...30	110	135	400	191	NN5002

f = flush / nf = non flush

Sensors with ATEX approval 1D / 1G / 2G







Type	Dimensions [mm]	Sensing range [mm]	Material	U _{nom.} at 1 KΩ [V]	U _b [V]	Internal capacit. [nF]	Internal inductance [μH]	f [Hz]	Draw- ing no.	Order no.
M12 connector · Output function  · Connection to certified intrinsically safe circuits with the max. values U = 15 V / I = 50 mA / P = 120 mW · Wiring diagram no. 23										
	M12 / L = 45	4 f	brass	8.2 DC	7.5...30	210	115	700	87	NF501A

Type	Dimensions [mm]	Sensing range [mm]	Material	U _{nom.} at 1 KΩ [V]	U _b [V]	Internal capacit. [nF]	Internal inductance [μH]	f [Hz]	Draw- ing no.	Order no.
M12 connector · Output function  · Connection to certified intrinsically safe circuits with the max. values U = 15 V / I = 50 mA / P = 120 mW · Wiring diagram no. 23										
	M12 / L = 50	7 nf	brass	8.2 DC	7.5...30	210	145	700	88	NF500A
	M18 / L = 46	8 f	brass	8.2 DC	7.5...30	200	190	400	93	NG501A
	M18 / L = 51	12 nf	brass	8.2 DC	7.5...30	200	85	300	94	NG500A
	M30 / L = 50	15 f	brass	8.2 DC	7.5...30	230	210	100	97	NI501A
	M30 / L = 50	22 nf	brass	8.2 DC	7.5...30	250	120	100	98	NI500A



M12 connector · Output function  · Connection to certified intrinsically safe circuits with the max. values U = 15 V / I = 50 mA / P = 120 mW · Wiring diagram no. 24										
	40 x 40 x 66	20 f	PPE	8.2 DC	7.5...30	250	450	200	83	NM500A
	40 x 40 x 66	35 nf	PPE	8.2 DC	7.5...30	220	710	100	83	NM501A



f = flush / nf = non flush

Switching amplifiers with ATEX approval

Type	U _b [V]	Power / current consumption [VA] / [mA]	f [Hz]	T _a [°C]	Output	Protection	Draw- ing no.	Order no.
	115	1.0 /	10	-20...60	relay (1 changeover contact)	IP20	192	N0030A
	230	1.0 /	10	-20...60	relay (1 changeover contact)	IP20	192	N0031A
	115	1.3 /	10	-20...60	relay (1 changeover contact per channel)	IP20	192	N0032A
	230	1.3 /	10	-20...60	relay (1 changeover contact per channel)	IP20	192	N0033A
	24	/ < 23	10	-20...60	relay (1 changeover contact)	IP20	192	N0530A
	24	/ < 50	5000	-20...60	2 transistor outputs PNP (100 mA, short-circuit protection)	IP20	192	N0531A
	24	/ < 50	5000	-20...60	2 outputs (optocoupler, bipolar, 100 mA, short-circuit protection)	IP20	192	N0532A
	24	/ < 50	10	-20...60	relay (1 changeover contact per channel)	IP20	192	N0533A
	24	/ < 50	5000	-20...60	2 transistor outputs PNP (100 mA, short-circuit protection)	IP20	192	N0534A



Sensors with ATEX approval 2D



Type	Dimensions [mm]	Sensing range [mm]	Material	U _b [V]	Protection	f [Hz]	I _{load} [mA]	Draw- ing no.	Order no.
M12 connector · Output function  · DC PNP · Wiring diagram no. 25									
	M30 / L = 70	14 f	high-grade st. steel	10...36	IP67	100	40	99	IIT23A



Terminals · Output function  /  · DC PNP · Wiring diagram no. 39									
	105 x 80 x 40	60 nf	PPE	10...36	IP65	4	40	193	ID501A



f = flush / nf = non flush



Sensors with ATEX approval 3D

Type	Dimensions [mm]	Sensing range [mm]	Material	U _b [V]	Protection	f [Hz]	I _{load} [mA]	Draw- ing no.	Order no.
Cable 2 m · Output function  · DC PNP · Wiring diagram no. 1									
	M12 / L = 35	2 f	brass	10...36	IP67	1500	150	41	IF501A

M12 connector · Output function  · DC PNP · Wiring diagram no. 2									
	M12 / L = 45	4 f	high-grade st. steel	10...36	IP67	700	100	87	IF520A
	M12 / L = 50	7 nf	high-grade st. steel	10...36	IP67	700	100	88	IF521A

M12 connector · Output function  · DC PNP · Wiring diagram no. 4									
	M12 / L = 45	4 f	high-grade st. steel	10...36	IP67	700	100	87	IFT20A





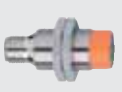





Cable 2 m · Output function  · DC PNP · Wiring diagram no. 1									
	M18 / L = 38	5 f	brass	18...36	IP67	500	150	47	IG504A
	M18 / L = 80	8 nf	brass	10...55	IP67	300	250	50	IG500A

Cable 2 m · Output function  · AC/DC · Wiring diagram no. 9									
	M18 / L = 80	8 nf	brass	20...250	IP67	25 / 50	200 / 100	50	IG000A*

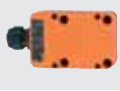
M12 connector · Output function  · DC PNP · Wiring diagram no. 2									
	M18 / L = 45	8 nf	brass	10...30	IP67	300	100	194	IG501A

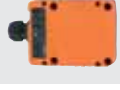
Type	Dimensions [mm]	Sensing range [mm]	Material	U _b [V]	Protection	f [Hz]	I _{load} [mA]	Drawing no.	Order no.
M12 connector · Output function  · DC PNP · Wiring diagram no. 2									
	M18 / L = 45	8 f	brass	10...30	IP67	250	100	195	IG503A
	M18 / L = 89	8 nf	brass	10...36	IP67	300	250	196	IG505A
	M18 / L = 46	8 f	brass	10...36	IP67	400	100	93	IGS20A
	M18 / L = 46	8 f	high-grade st. steel	10...36	IP67	500	100	93	IGT20A
	M18 / L = 51	12 nf	brass	10...36	IP67	300	100	94	IGS21A
Cable 6 m · Output function  · AC/DC · Wiring diagram no. 9									
	M30 / L = 81	15 nf	brass	20...250	IP67	25 / 50	200 / 100	62	I1000A*
M12 connector · Output function  · DC PNP · Wiring diagram no. 2									
	M30 / L = 50	14 f	high-grade st. steel	10...36	IP67	100	100	97	IIT20A
	M30 / L = 50	22 nf	high-grade st. steel	10...36	IP67	100	100	98	IIT21A
Cable 2 m · Output function  · DC PNP · Wiring diagram no. 1									
	40 x 12 x 26	2 f	PBT	10...36	IP67	1400	250	69	IN502A
Cable 10 m · Output function  · DC PNP · Wiring diagram no. 1									
	40 x 12 x 26	4 nf	PBT	10...36	IP67	1300	250	69	IN504A
M12 connector · Output function  · DC PNP · Wiring diagram no. 13									
	40 x 40 x 66	35 nf	PPE	10...36	IP67	100	200	197	IM500A
	40 x 40 x 66	20 f	PPE	10...36	IP67	200	200	197	IM501A
Terminals · Output function  · AC/DC · Wiring diagram no. 11									
	40 x 40 x 121	15 f	PPE	20...250	IP54	25 / 70	150 / 100	198	IM000A*
Terminals · Output function  · DC PNP · Wiring diagram no. 5									
	40 x 40 x 121	20 nf	PPE	10...36	IP54	350	250	198	IM502A

Inductive sensors







Type	Dimensions [mm]	Sensing range [mm]	Material	U _b [V]	Protection	f [Hz]	I _{load} [mA]	Draw- ing no.	Order no.
Terminals · Output function  /  · AC/DC · Wiring diagram no. 33									
	90 x 60 x 40	40 nf	PPE	20...250	IP54	10	200 / 100	199	IC000A*
Terminals · Output function  /  · DC PNP · Wiring diagram no. 32									
	90 x 60 x 40	40 nf	PPE	10...30	IP54	10	250	199	IC500A
Terminals · Output function  /  · AC/DC · Wiring diagram no. 33									
	105 x 80 x 40	60 nf	PPE	20...250	IP65	4	200 / 100	193	ID000A*
Terminals · Output function  /  · DC PNP · Wiring diagram no. 32									
	105 x 80 x 40	60 nf	PPE	10...36	IP65	100	250	193	ID500A

f = flush / nf = non flush

* Note for AC and AC/DC units

Miniature fuse to IEC60127-2 sheet 1, ≤ 2 A (fast acting). Recommendation: check the unit for reliable function after a short circuit.















Accessories

Type	Description	Order no.
	Angle bracket · for type M8 · Housing materials: stainless steel	E10734
	Angle bracket · for type M12 · Housing materials: stainless steel	E10735
	Angle bracket · for type M18 · Housing materials: stainless steel	E10736
	Angle bracket · for type M30 · Housing materials: stainless steel	E10737
	Mounting bracket · with integrated snap-on rail · for type IDC · Housing materials: stainless steel	E10730
	Protective bracket · for cable units · for type IW, KW, OW · Housing materials: stainless steel 316Ti / 1.4571	E20813
	Mounting clamp · Ø 6.5 mm · Housing materials: PPE	E10014

Type	Description	Order no.
	Mounting clamp · Ø 8 mm · with end stop · for type M8 · Housing materials: PC	E11521
	Mounting clamp · Ø 12 mm · Housing materials: PBT	E10015
	Mounting clamp · Ø 20 mm · Housing materials: PBT	E10016
	Mounting clamp · Ø 34 mm · Housing materials: PBT	E10017
	Mounting clamp · Ø 20 mm - Ø 18 mm · with reducing bush · for type M18 · Housing materials: PBT	E10076
	Mounting clamp · Ø 34 mm - Ø 30 mm · with reducing bush · for type M30 · Housing materials: PBT	E10077
	Mounting clamp · Ø 20 mm · Housing materials: PA	E10192
	Mounting clamp · Ø 34 mm · Housing materials: PA	E10193
	Mounting clamp · Ø 4 mm · Housing materials: TPE	E10204
	Mounting clamp · Ø 8 mm · Housing materials: aluminium black anodised	E10221
	Mounting clip · Ø 12 mm · for smooth body switches - Ø 12 mm · Form V · Housing materials: V4A	E11530
	Mounting clip · Ø 18 mm · for smooth body switches - Ø 18 mm · Form V · Housing materials: V4A	E11531
	Mounting clip · Form O · for type M12 · Housing materials: stainless steel	E11533
	Mounting clip · Form O · for type M18 · Housing materials: stainless steel	E11534

Type	Description	Order no.
	Mounting adapter · G 3/4 - M18 x 1 · for type M18 x 1 · Housing materials: PTFE	E10698
	Mounting sleeve · M16 x 1 - Ø 12 mm · with end stop · Knurled nut · for type M12 · Housing materials: steel galvanised, chromium-plated (yellow)	E11513
	Mounting sleeve · M22 x 1 - Ø 18 mm · with end stop · Knurled nut · for type M18 · Housing materials: steel galvanised	E11514
	Mounting sleeve · M16 x 1 - Ø 12 mm · 45 mm · with end stop · for type M12 · Housing materials: brass nickel-plated	E10741
	Mounting sleeve · M24 x 1.5 - Ø 18 mm · 58 mm · with end stop · for type M18 · Housing materials: brass nickel-plated	E10742
	Mounting sleeve · M36 x 1.5 - Ø 30 mm · 58 mm · with end stop · for type M30 · Housing materials: brass nickel-plated	E10743
	Mounting sleeve · M16 x 1 - Ø 12 mm · 34 mm · with end stop · for type M12 · Housing materials: brass nickel-plated	E10806
	Mounting sleeve · M24 x 1.5 - Ø 18 mm · 36 mm · with end stop · for type M18 · Housing materials: brass nickel-plated	E10807
	Mounting sleeve · M36 x 1.5 - Ø 30 mm · 36 mm · with end stop · for type M30 · Housing materials: brass nickel-plated	E10808
	Mounting sleeve · M12 x 1 - Ø 8 mm · 32 mm · with end stop · for type M8 · Housing materials: brass special coated	E10848
	Mounting sleeve · M12 x 1 - Ø 8 mm · 42 mm · with end stop · for type M8 · Housing materials: brass special coated	E10849
	Mounting clamp · Ø 12 mm · with end stop · for type M12 · Housing materials: PC	E11047
	Mounting clamp · Ø 18 mm · with end stop · for type M18 · Housing materials: PC	E11048
	Mounting clamp · Ø 30 mm · with end stop · for type M30 · Housing materials: PC	E11049

Type	Description	Order no.
	Mounting sleeve · M16 x 1 - Ø 12 mm · with end stop · for type M12 · Housing materials: brass nickel-plated	E11114
	Mounting sleeve · M22 x 1 - Ø 18 mm · with end stop · for type M18 · Housing materials: brass white bronze coated	E11115
	Mounting set · straight · Clamp mounting · for type IA, IB, KA, KB · Housing materials: clamp: stainless steel / fixture: stainless steel 316Ti / 1.4571	E11117
	Mounting set · angled · Clamp mounting · for type IA, IB, KA, KB · Housing materials: clamp: stainless steel / fixture: stainless steel 316Ti / 1.4571	E11118
	Mounting set · angled · only for flush-mountable sensors · Clamp mounting · rod mounting Ø 14 mm · for type IME, IMC · Housing materials: clamp: stainless steel / fixture: stainless steel 316Ti / 1.4571	E11119
	Mounting set · straight · only for flush-mountable sensors · Clamp mounting · rod mounting Ø 14 mm · for type IME, IMC · Housing materials: clamp: stainless steel / fixture: stainless steel 316Ti / 1.4571	E11120
	Mounting set · angled · Clamp mounting · rod mounting Ø 14 mm · for type ICE, ID, KD · Housing materials: clamp: stainless steel / fixture: stainless steel 316Ti / 1.4571	E11121
	Mounting set · straight · Clamp mounting · rod mounting Ø 14 mm · for type ICE, ID, KD · Housing materials: clamp: stainless steel / fixture: stainless steel 316Ti / 1.4571	E11122
	Mounting set · Ø 18.5 mm · Clamp mounting · free-standing M10 · for type OG, IG, KG · Housing materials: clamp: diecast zinc / fixture: steel	E20718
	Mounting set · Ø 18.5 mm · Clamp mounting · free-standing M10 · for type OG, IG, KG · Housing materials: clamp: diecast zinc / fixture: steel	E20719
	Angle bracket · Clamp mounting · for type IW, KQ, OW · Housing materials: stainless steel 316Ti / 1.4571	E20811
	Protective bracket · for cable units · for type IW, KW, OW · Housing materials: stainless steel 316Ti / 1.4571	E20813
	Protective bracket · for devices with M8 connection · for type OW, IW · Housing materials: stainless steel 316Ti / 1.4571	E20814
	Mounting set · Ø 12.2 mm · Clamp mounting · free-standing M8 · for type OF, IF · Housing materials: fixture: stainless steel 316Ti / 1.4571 / clamp: diecast zinc	E20856

Type	Description	Order no.
	Mounting set · Ø 12.2 mm · Clamp mounting · free-standing M8 · for type OF, IF · Housing materials: fixture: stainless steel 316Ti / 1.4571 / clamp: stainless steel	E20857
	Mounting set · Ø 12.2 mm · Clamp mounting · free-standing M8 · for type OF, IF · Housing materials: fixture: stainless steel 316Ti / 1.4571 / clamp: diecast zinc	E20860
	Mounting set · Ø 12.2 mm · Clamp mounting · free-standing M8 · for type OF, IF · Housing materials: fixture: stainless steel 316Ti / 1.4571 / clamp: stainless steel	E20861
	Mounting set · Ø 12.2 mm · Clamp mounting · aluminium profile · for type OF, IF · Housing materials: fixture: stainless steel 316Ti / 1.4571 / clamp: diecast zinc / Cube: diecast zinc	E20864
	Mounting set · Ø 12.2 mm · Clamp mounting · aluminium profile · for type OF, IF · Housing materials: fixture: stainless steel 316Ti / 1.4571 / clamp: diecast zinc / Cube: diecast zinc	E20865
	Mounting set · Ø 18.5 mm · Clamp mounting · aluminium profile · for type OG, IG, KG · Housing materials: fixture: stainless steel 316Ti / 1.4571 / clamp: diecast zinc / Cube: diecast zinc	E20866
	Mounting set · Ø 18.5 mm · Clamp mounting · aluminium profile · for type OG, IG, KG · Housing materials: fixture: stainless steel 316Ti / 1.4571 / clamp: diecast zinc / Cube: diecast zinc	E20867
	Mounting set · Ø 18.5 mm · Clamp mounting · free-standing M10 · for type OG, IG, KG · Housing materials: fixture: stainless steel 316Ti / 1.4571 / clamp: stainless steel	E20869
	Mounting set · Ø 18.5 mm · Clamp mounting · free-standing M10 · for type OG, IG, KG · Housing materials: fixture: stainless steel 316Ti / 1.4571 / clamp: stainless steel	E20870
	Mounting set · Ø 30.2 mm · Clamp mounting · free-standing M12 · for type OI, II, KI · Housing materials: fixture: stainless steel 316Ti / 1.4571 / clamp: diecast zinc	E20873
	Mounting set · Ø 30.2 mm · Clamp mounting · free-standing M12 · for type OI, II, KI · Housing materials: fixture: stainless steel 316Ti / 1.4571 / clamp: stainless steel	E20874
	Mounting set · Ø 30.2 mm · Clamp mounting · aluminium profile · for type OI, II, KI · Housing materials: fixture: stainless steel 316Ti / 1.4571 / clamp: diecast zinc / Cube: diecast zinc	E20875
	Limit plungers · for types M8 x 1 · with Sn = 1 mm f, 2 mm f and 3 mm f · Housing materials: Limit plungers: free cutting steel / plunger: C45K hardened on front / nut: brass nickel-plated	E10154
	Limit plungers · for type Ø 6.5 mm · with Sn = 1 mm f · Housing materials: Limit plungers: free cutting steel / plunger: C45K hardened on front / nut: brass nickel-plated	E10155

Type	Description	Order no.
------	-------------	-----------



Plastic nut for flow plate · M18 x 1 · Housing materials: POM

E19503

Wiring diagrams

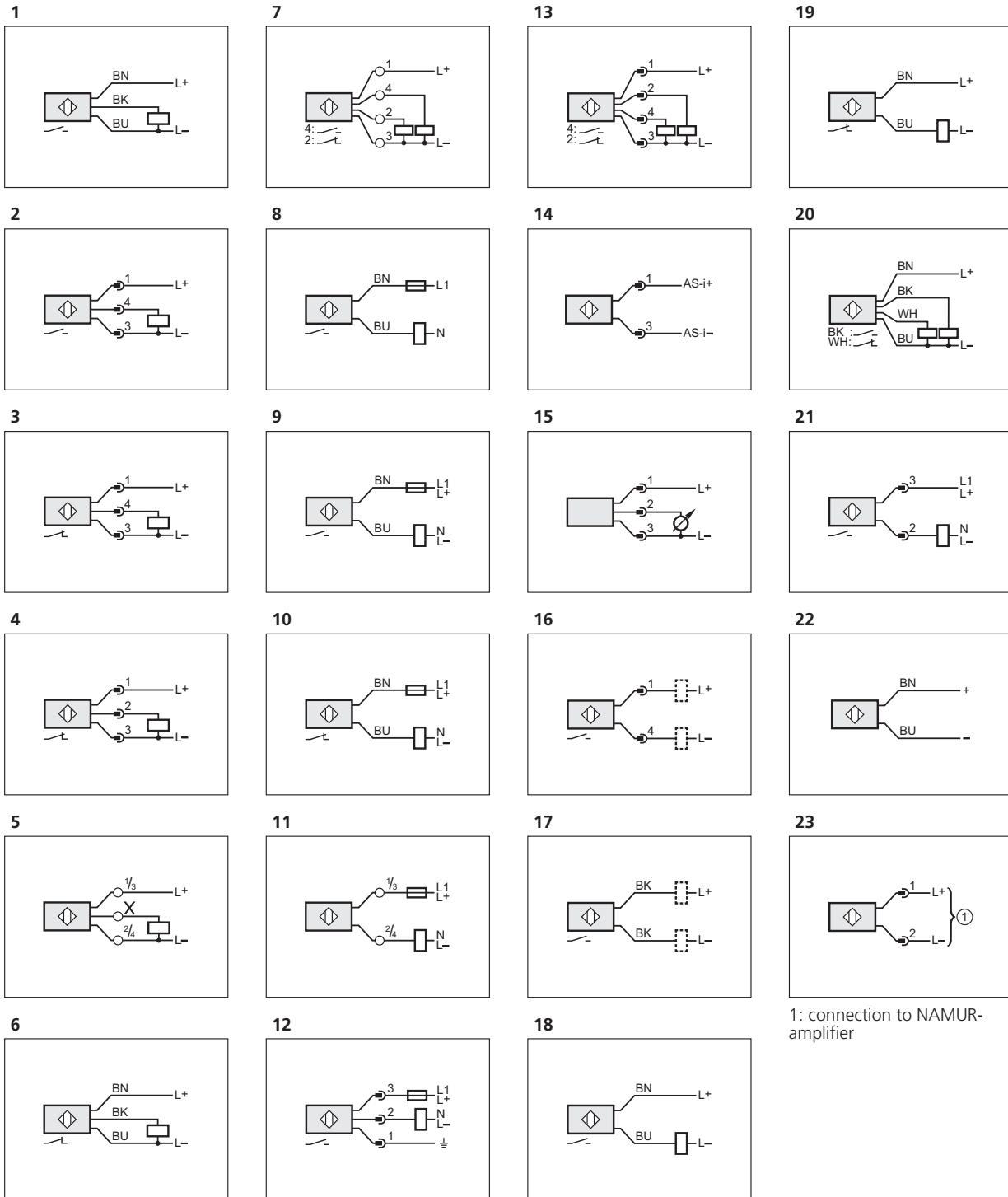

Wiring diagrams

24

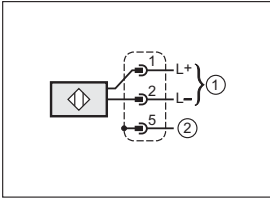

1: connection to NAMUR-amplifier, 2: Potential equalisation plug housing

25

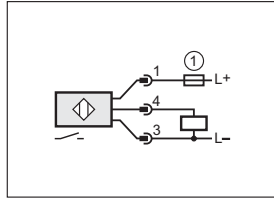

1: fuse

26

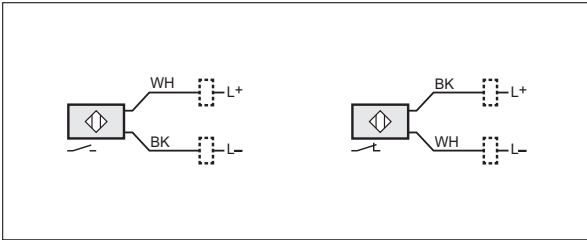

31

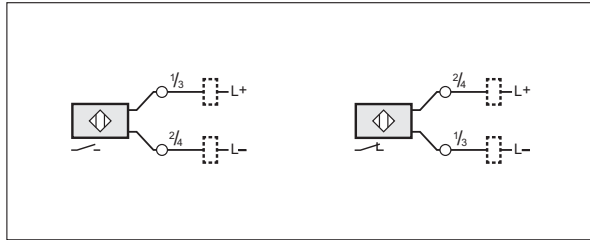

27

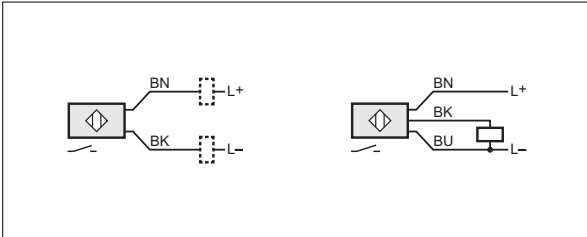

32

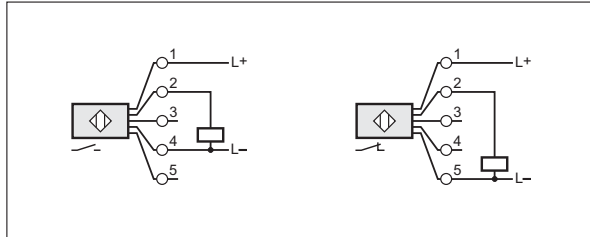

28

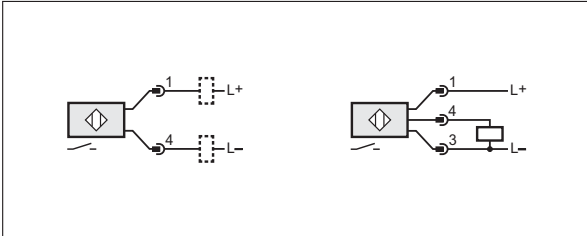

33

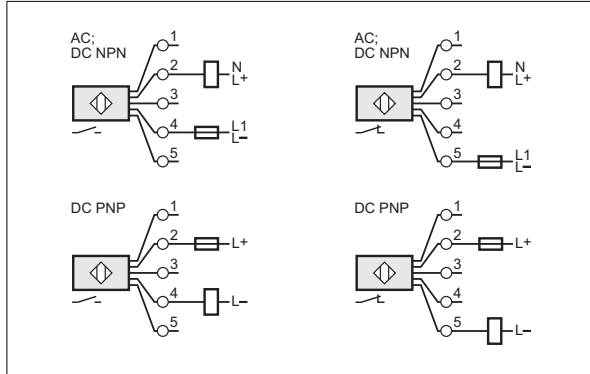

29

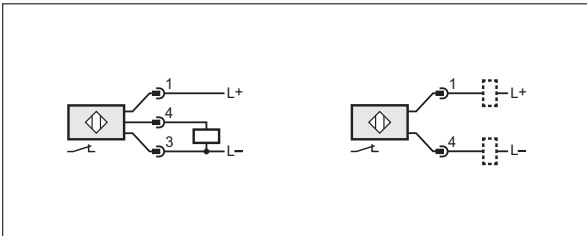

34

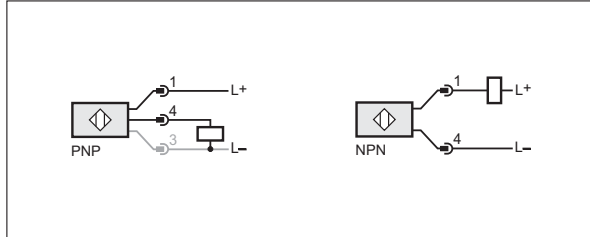

30

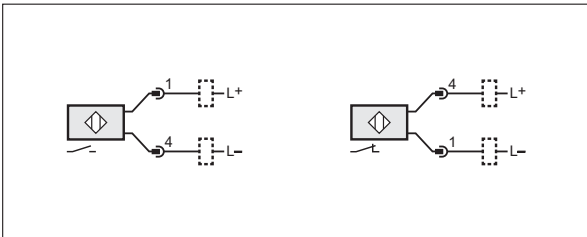

Wiring diagrams

35

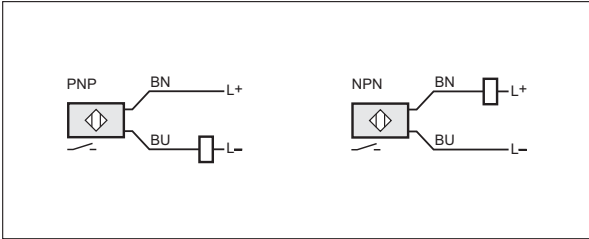

38

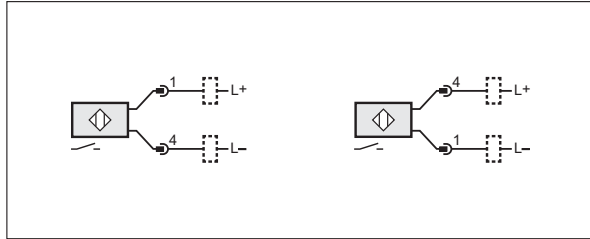

36

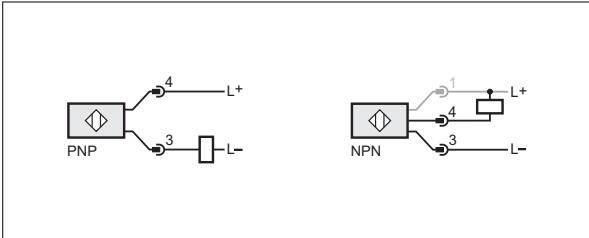

39

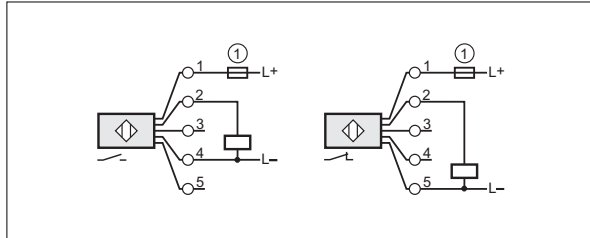

1: fuse

37

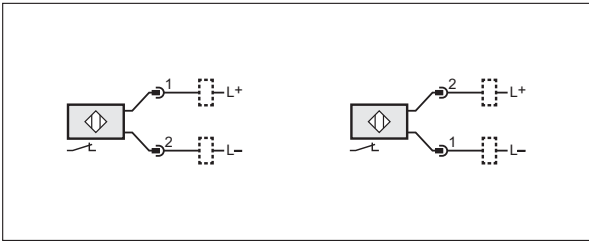

Scale drawings

1

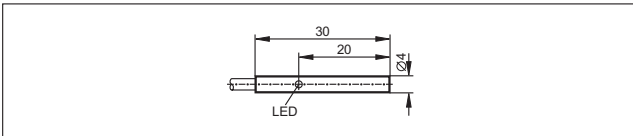

5

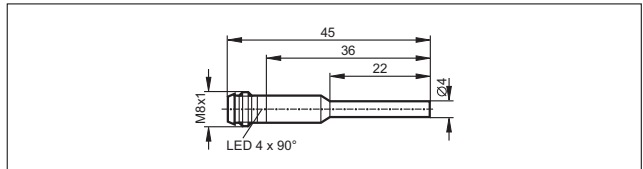

2

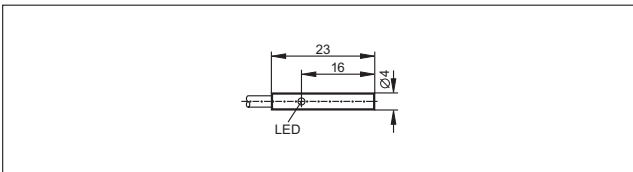

6

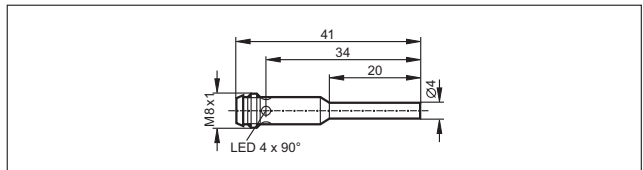

3

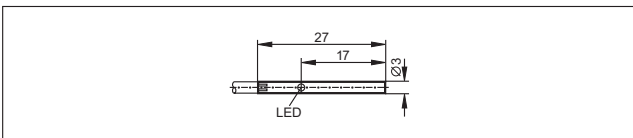

7

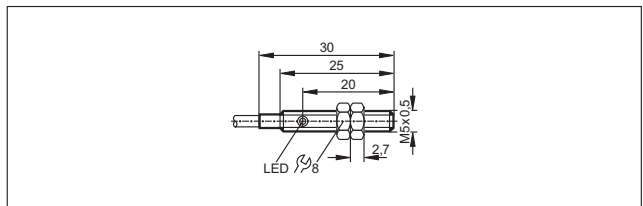

Scale drawings

8

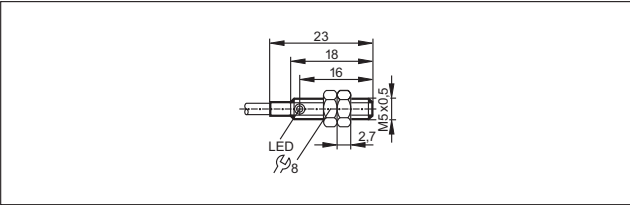

9

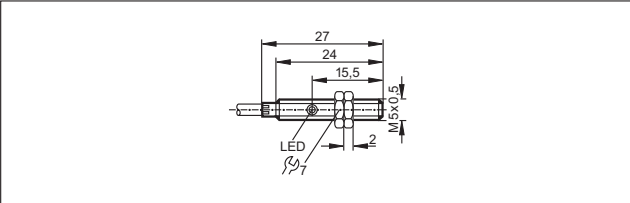

10

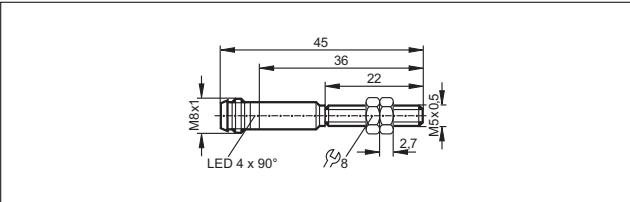

11

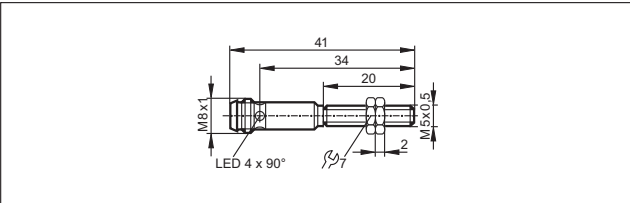

12

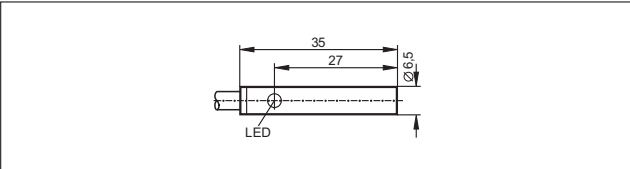

13

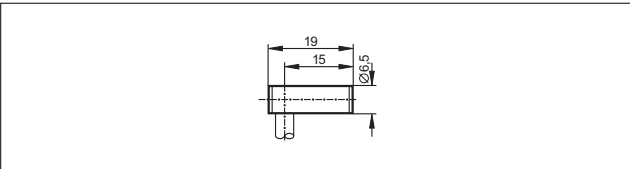

14

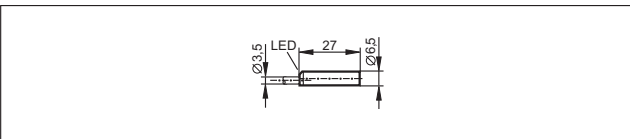

15

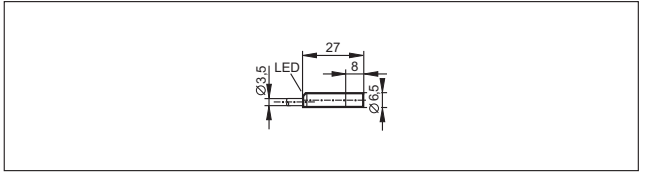

16

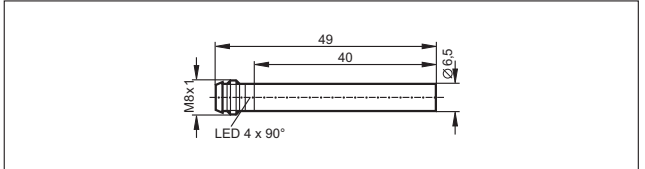

17

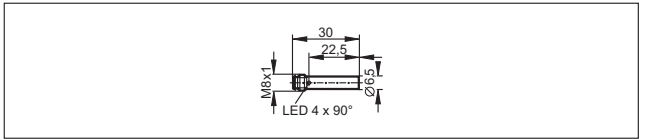

18

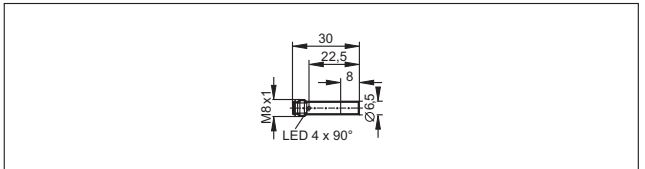

19

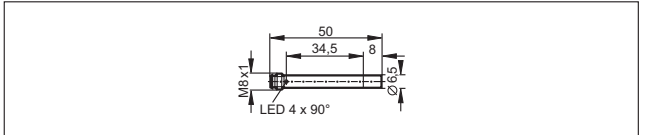

20

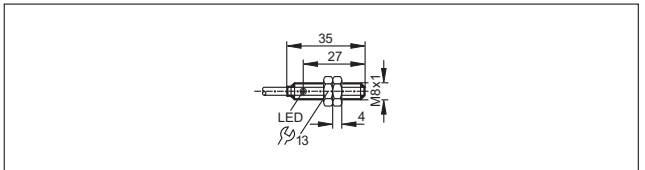

21

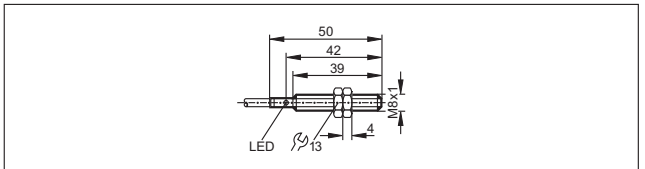

22

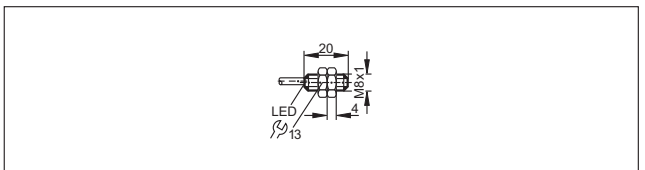

Scale drawings

23

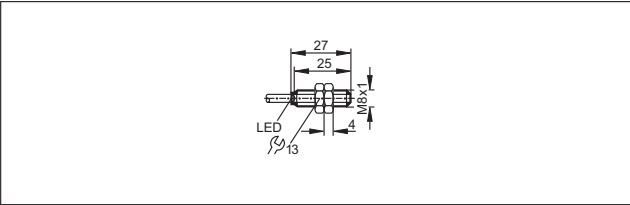

30

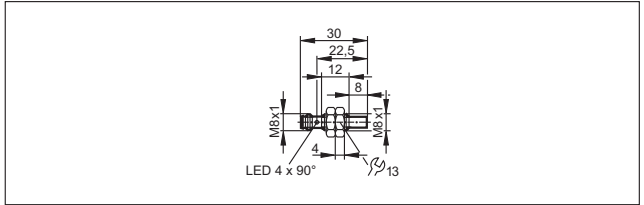

24

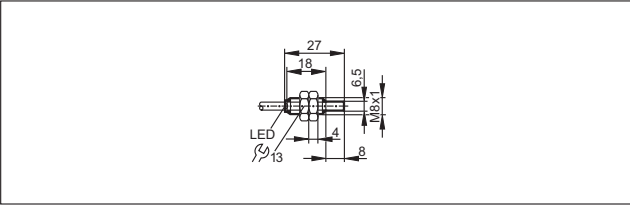

31

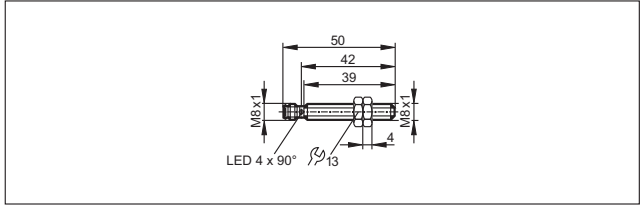

25

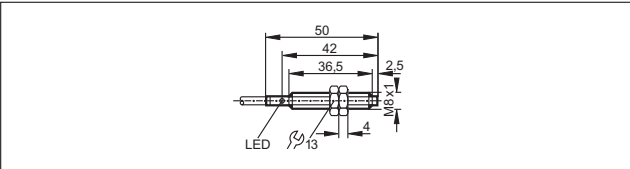

32

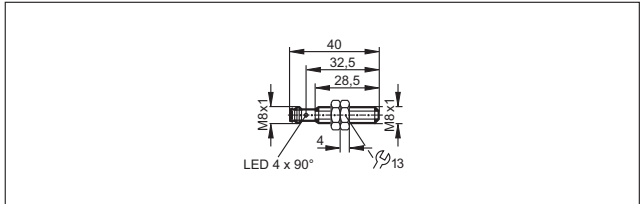

26

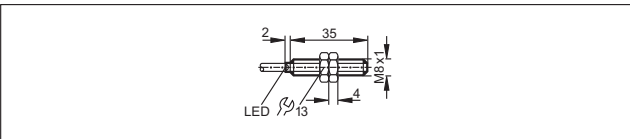

33

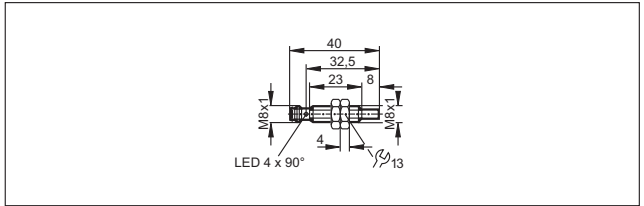

27

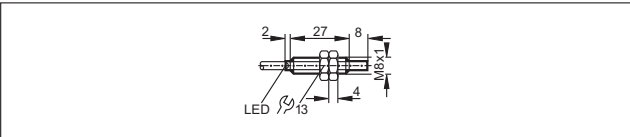

34

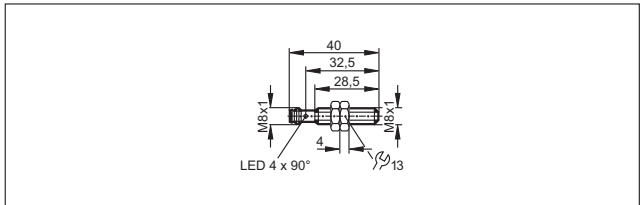

28

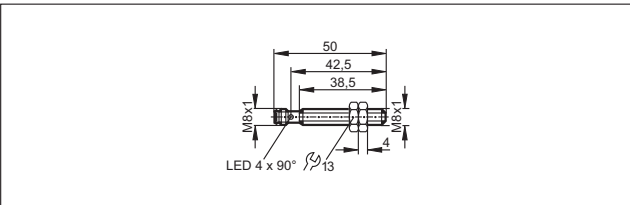

35

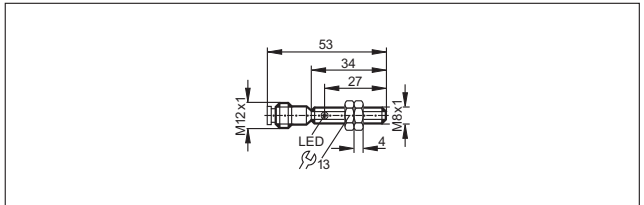

29

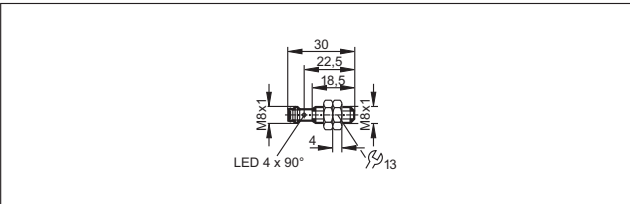

36

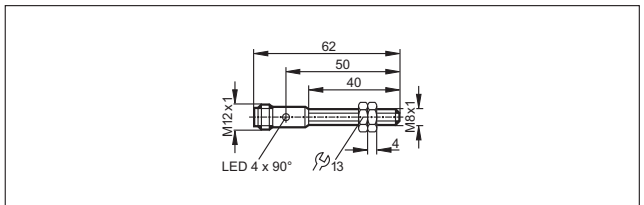

Scale drawings

37

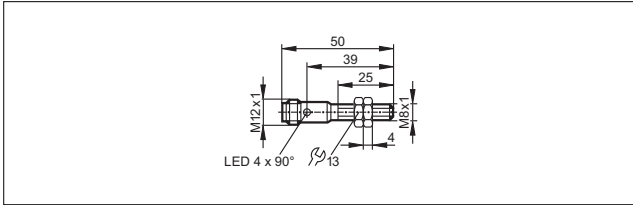

44

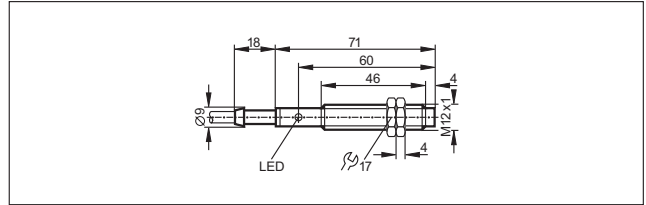

38

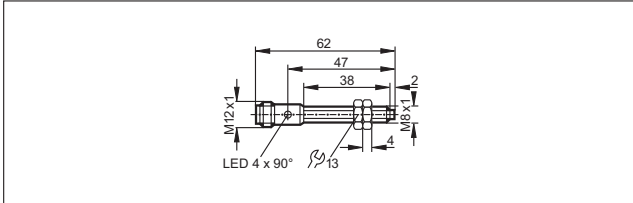

45

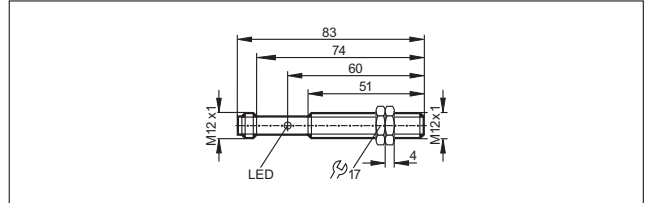

39

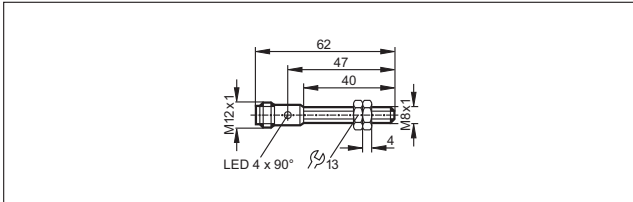

46

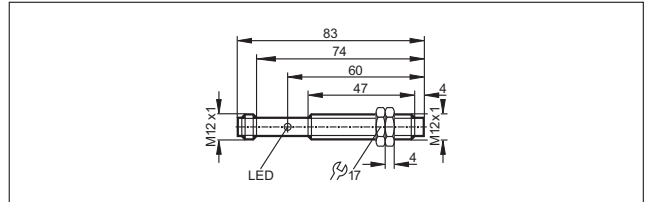

40

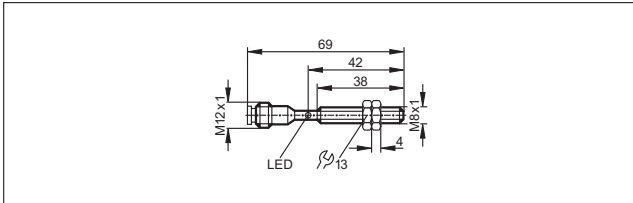

47

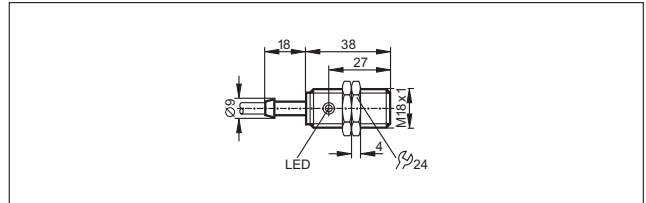

41

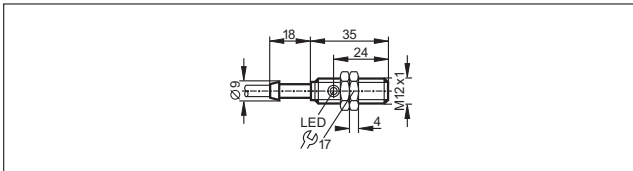

48

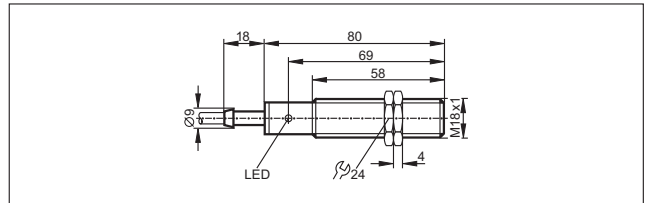

42

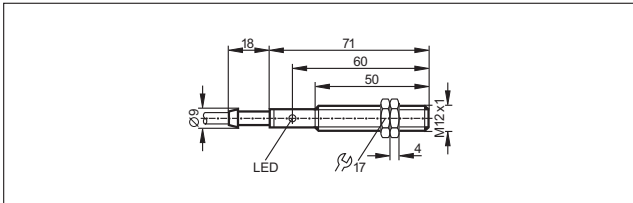

49

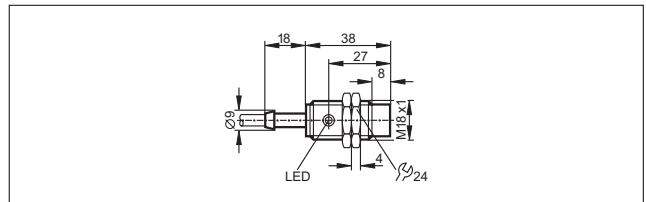

43

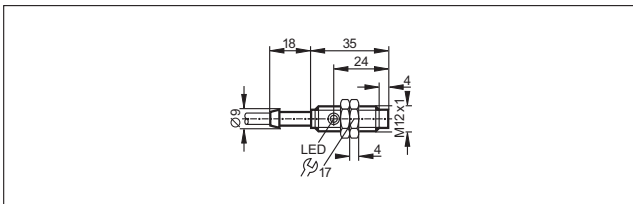

50

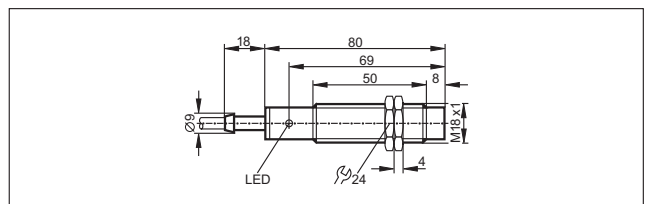

Scale drawings

51

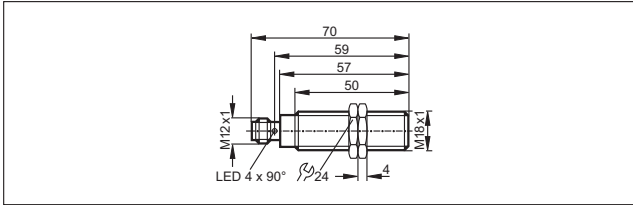

52

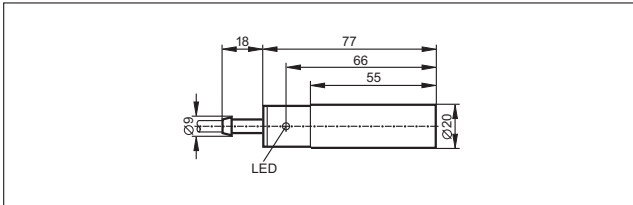

53

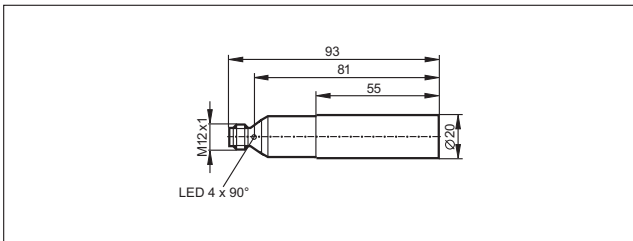

54

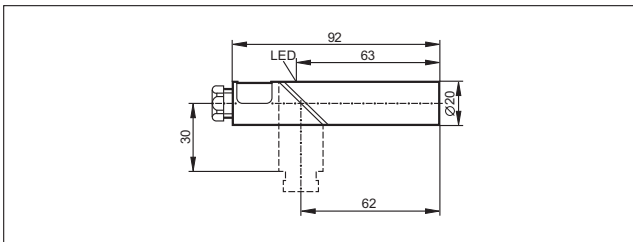

55

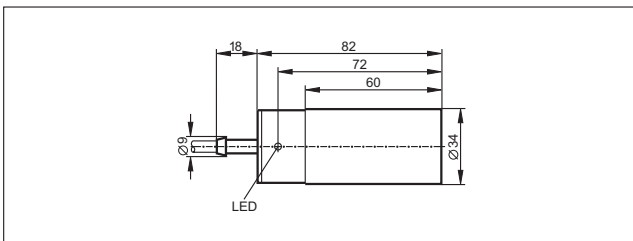

56

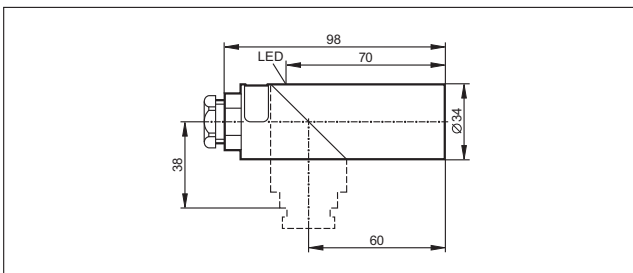

57

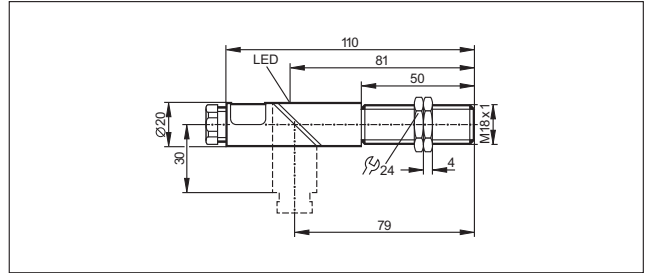

58

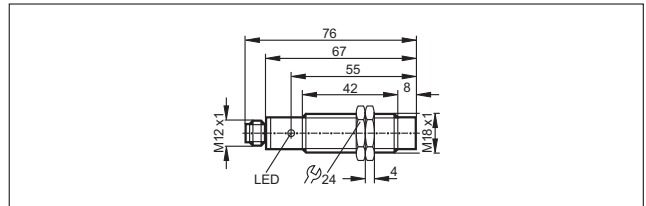

59

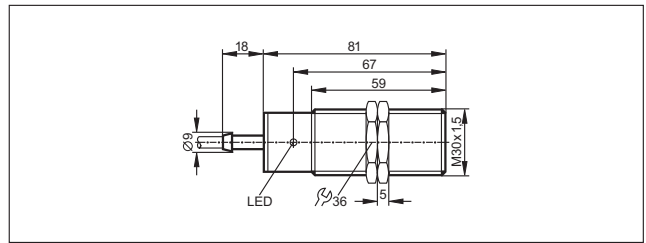

60

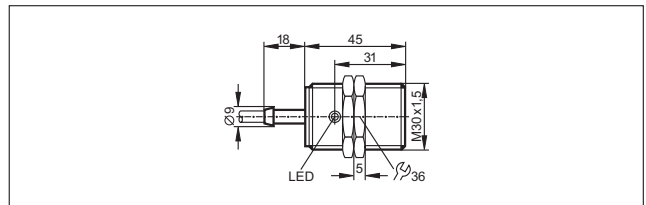

61

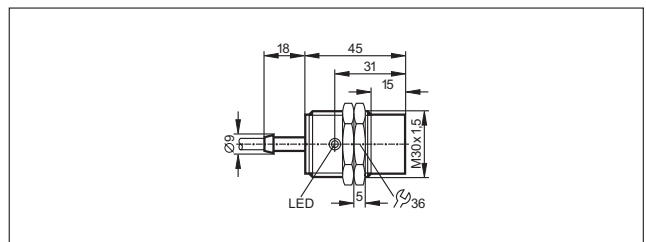

62

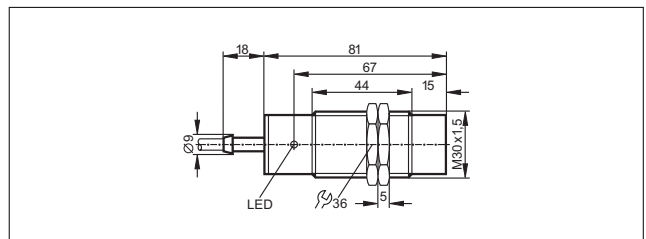

Scale drawings

63

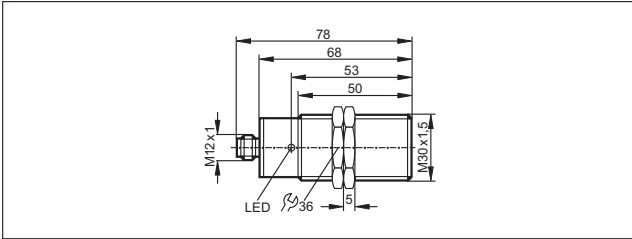

64

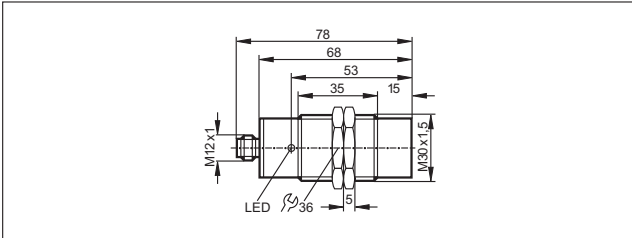

65

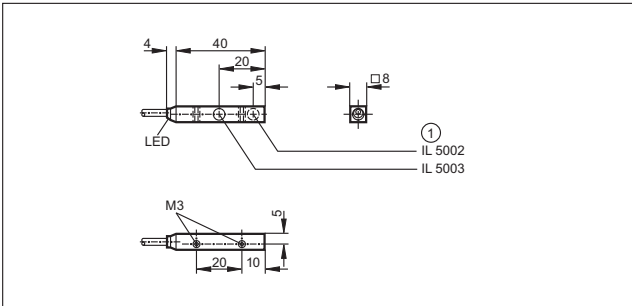

1: sensing face

66

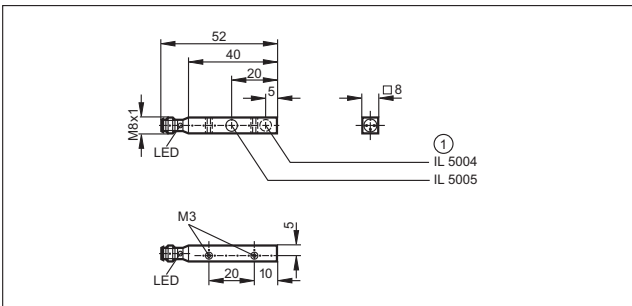

1: sensing face

67

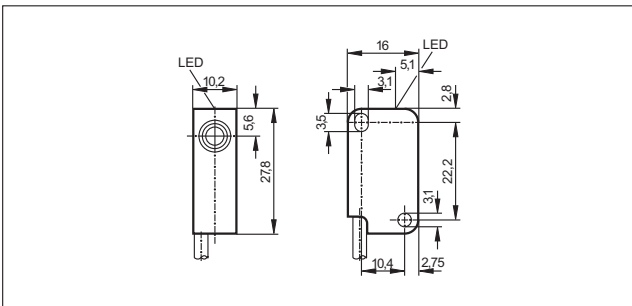

68

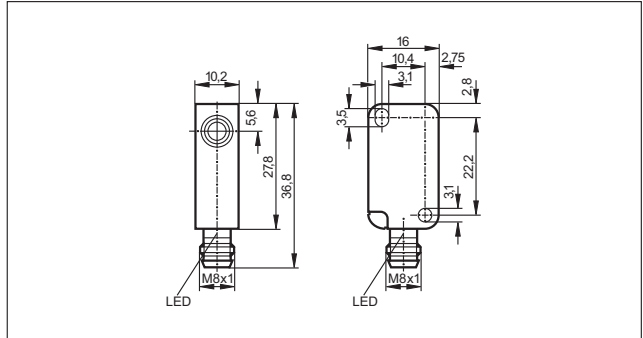

69

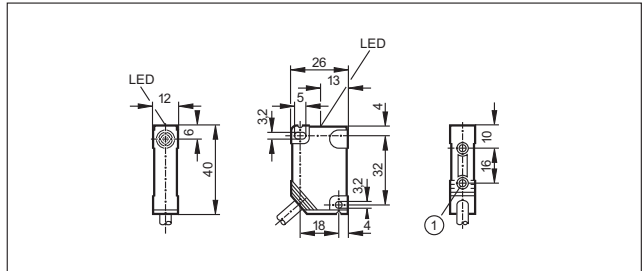

1: threaded insert M3, depth 5.8 mm, max. tightening torque 1.2 Nm (screw fixing class 8.8) when brass insert in contact with counterpart.

70

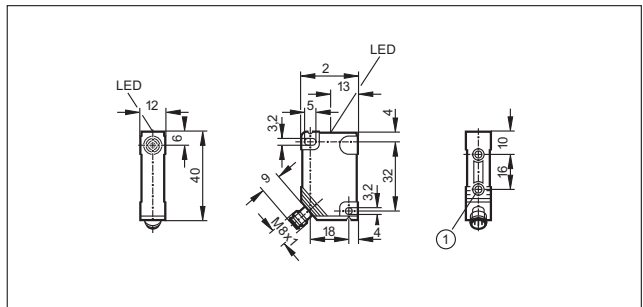

1: threaded insert M3, depth 5.8 mm, max. tightening torque 1.2 Nm (screw fixing class 8.8) when brass insert in contact with counterpart.

71

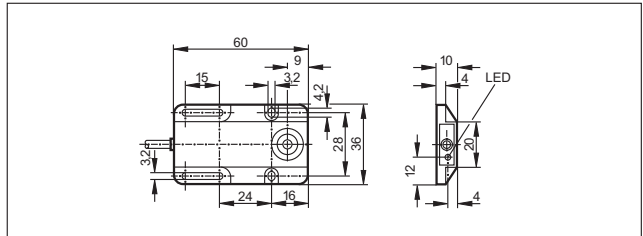

Scale drawings

72

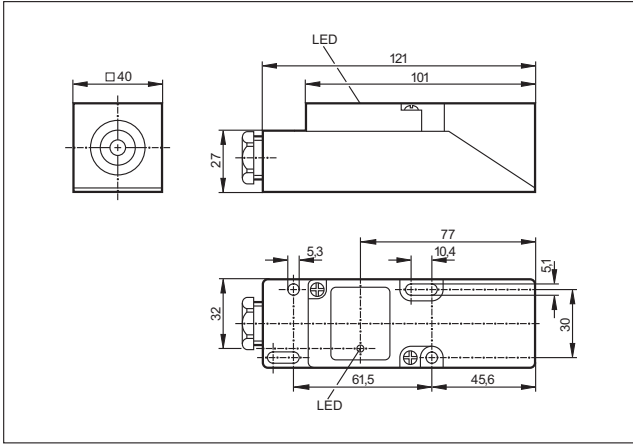

73

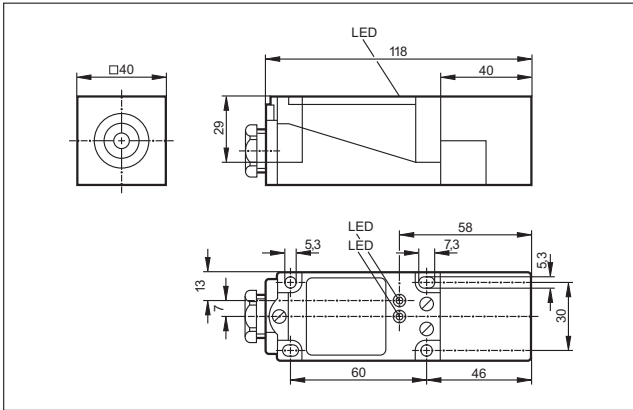

74

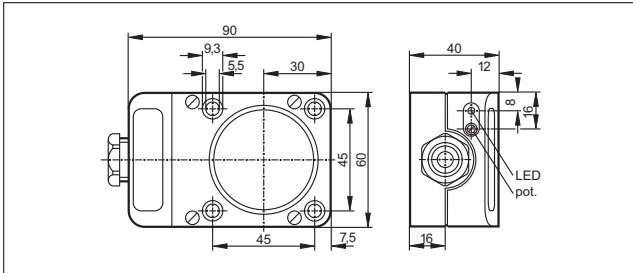

75

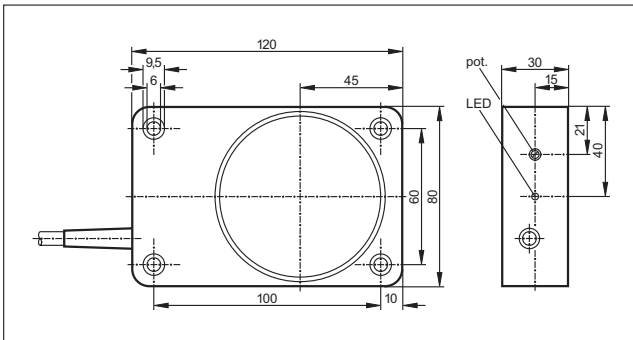

76

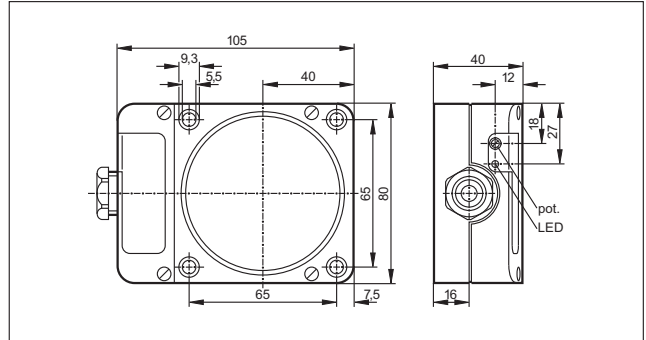

77

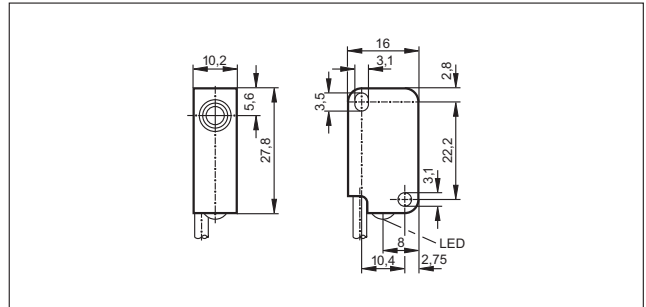

78

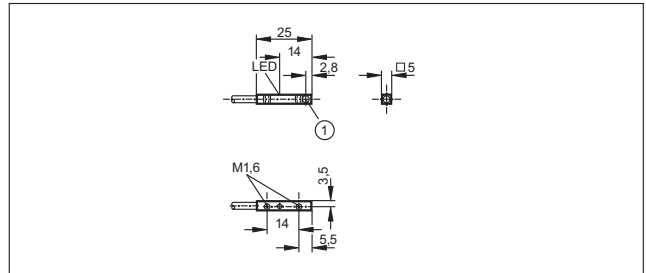

1: sensing face

79

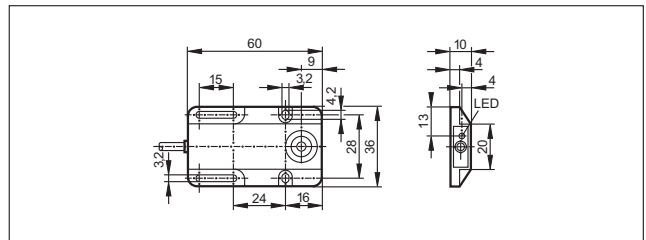

80

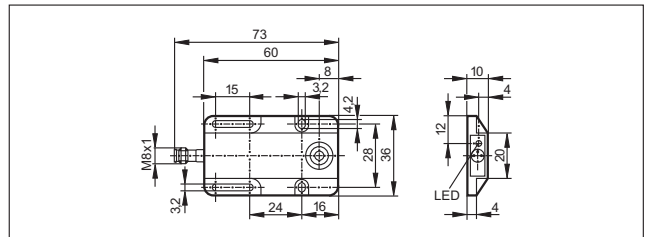

Scale drawings

81

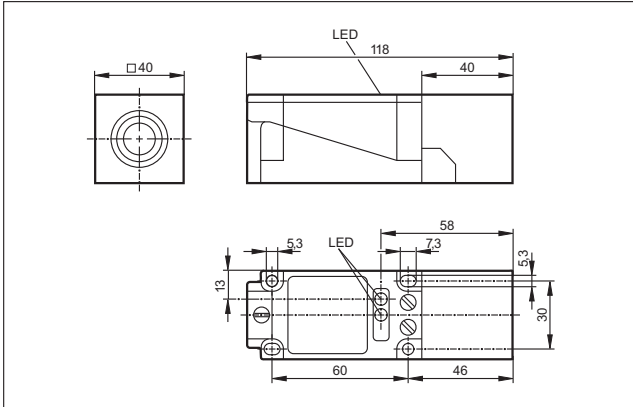

82

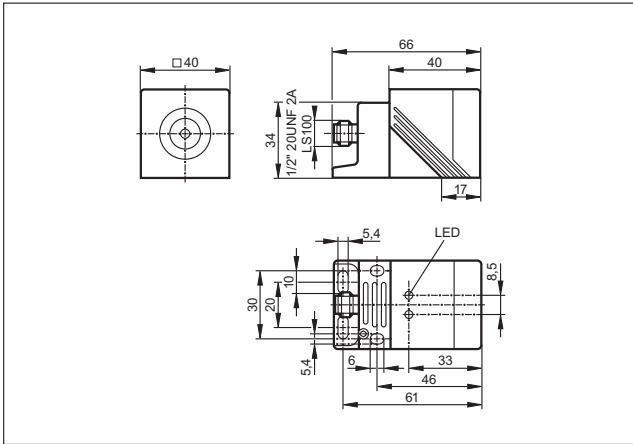

83

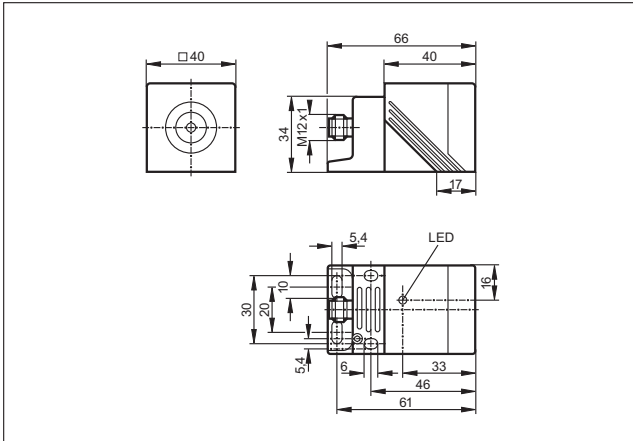

84

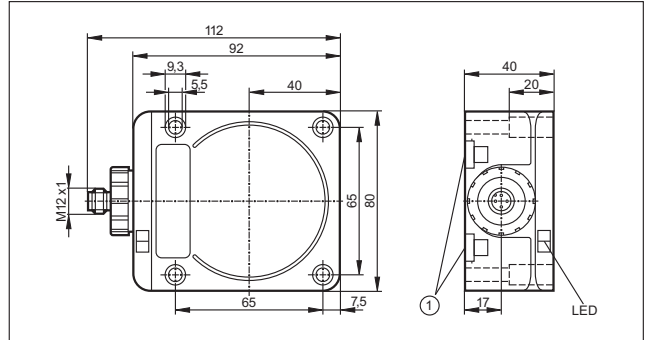

1: mounting on DIN rail

85

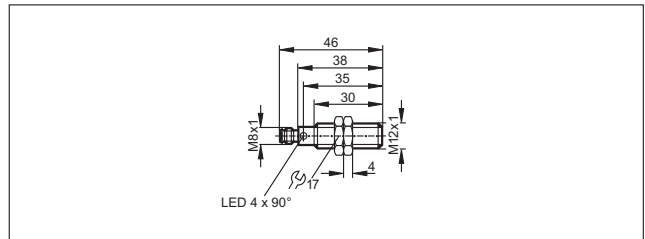

86

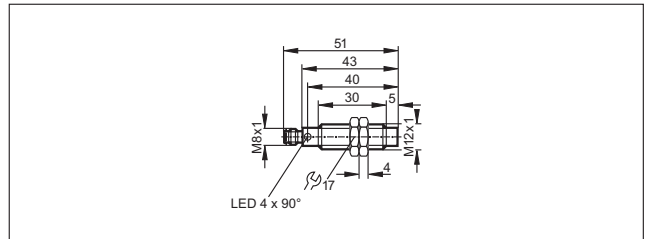

87

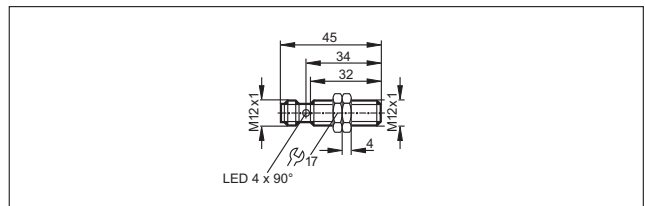

88

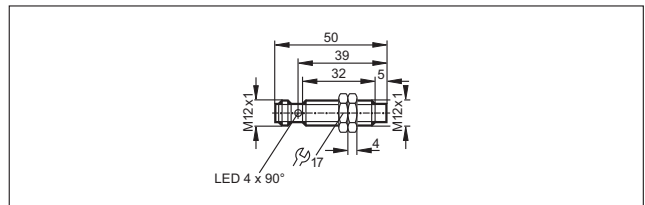

89

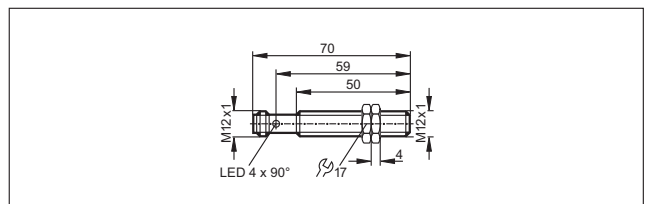

Scale drawings

90

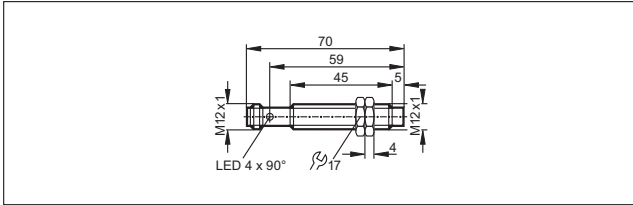

96

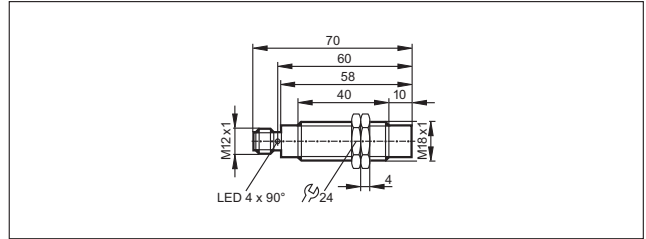

91

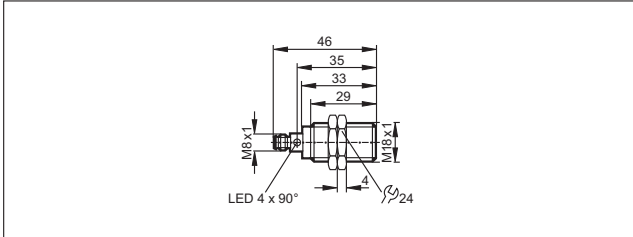

97

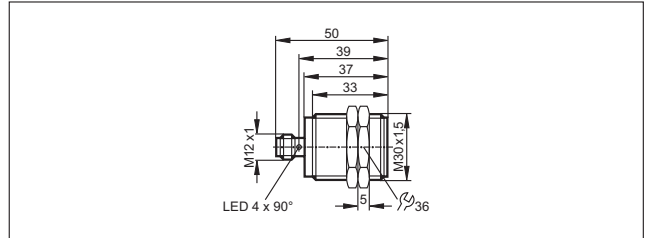

92

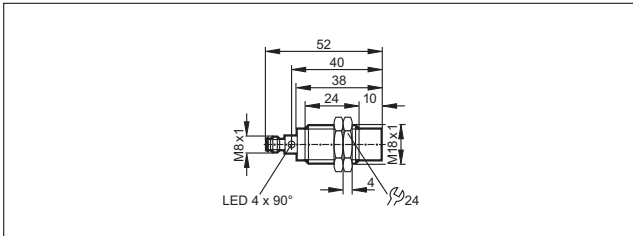

98

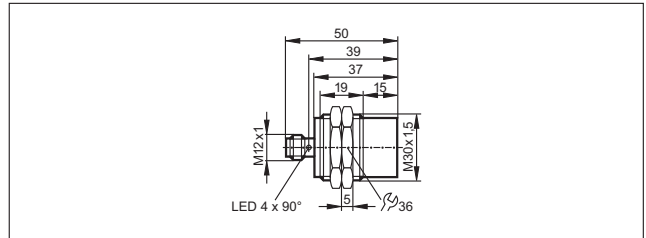

93

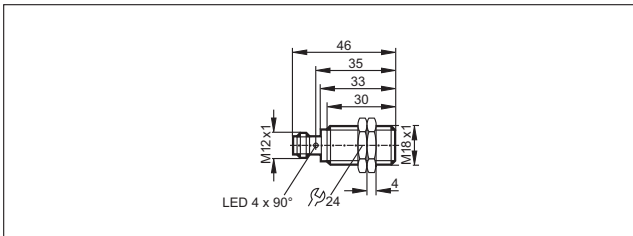

99

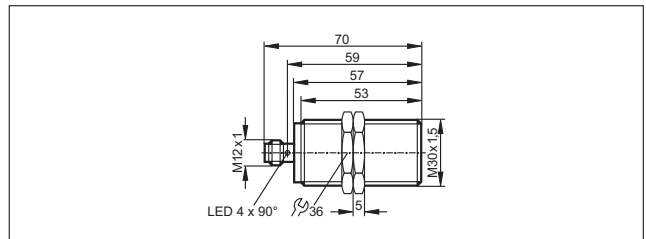

94

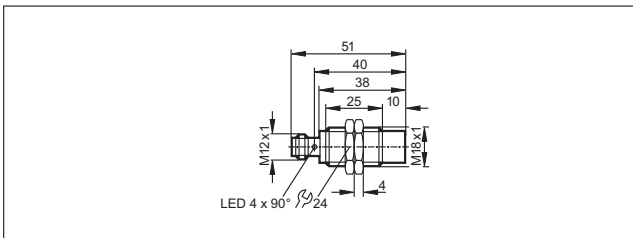

100

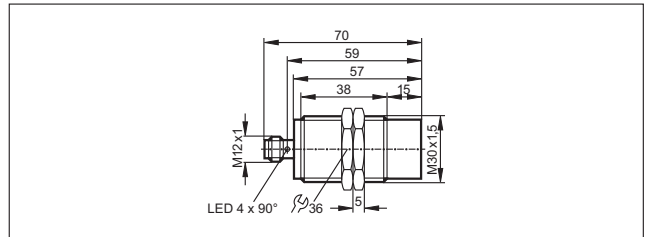

95

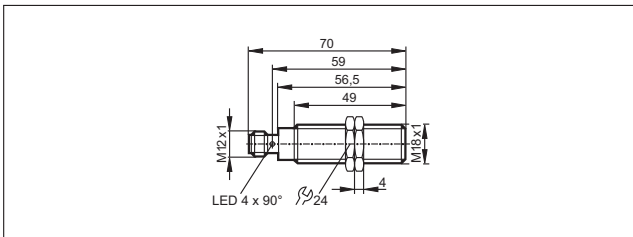

Scale drawings

101

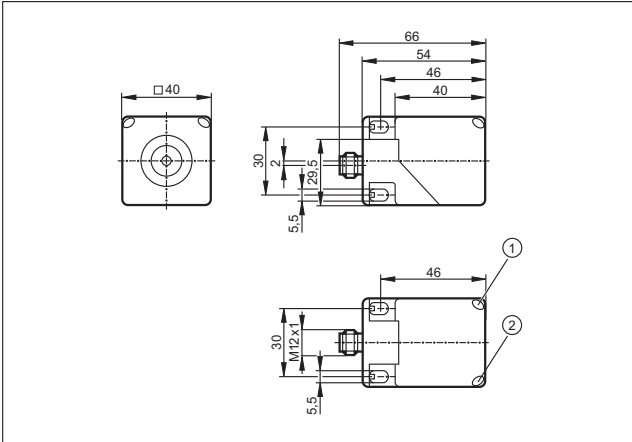

1: LED yellow, 2: LED green

102

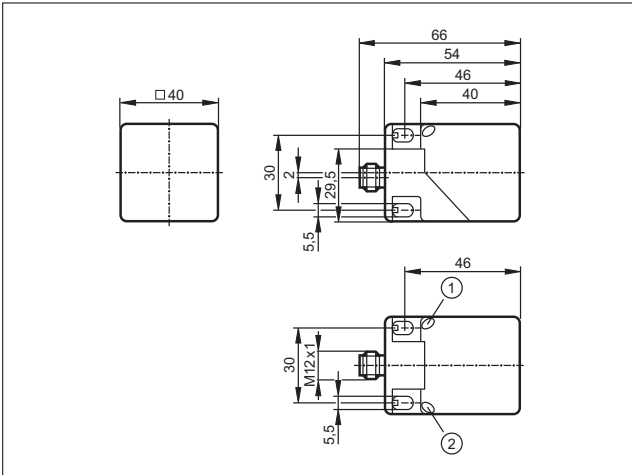

1: LED yellow, 2: LED green

103

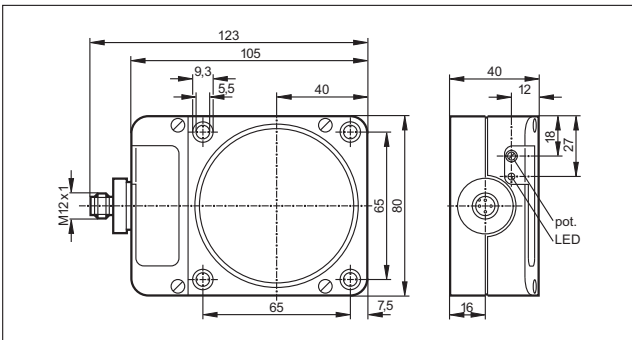

104

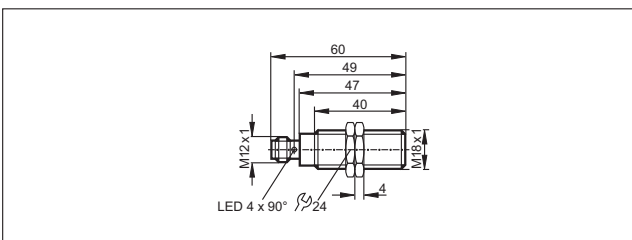

105

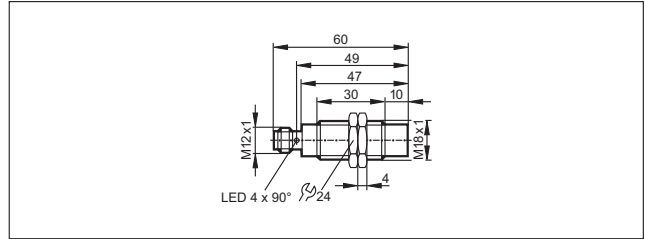

106

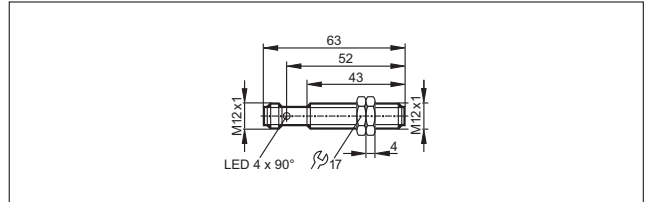

107

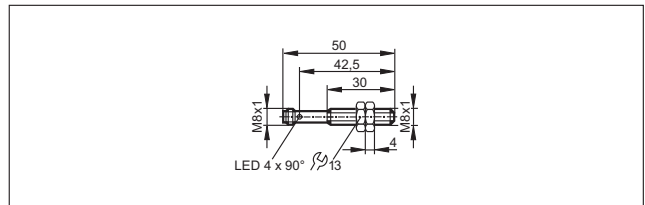

108

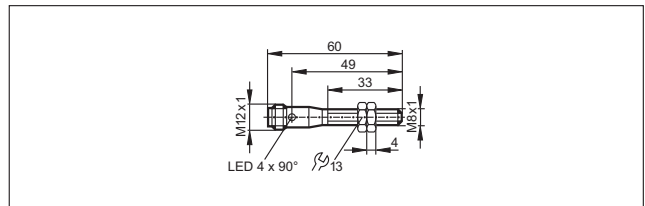

109

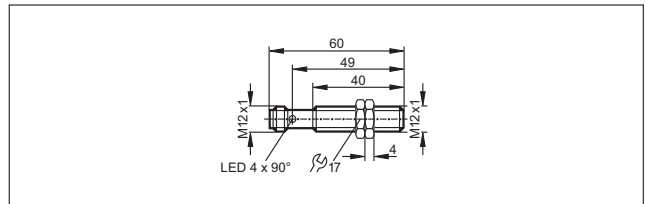

110

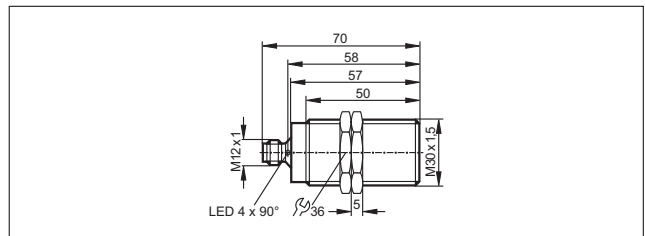

111

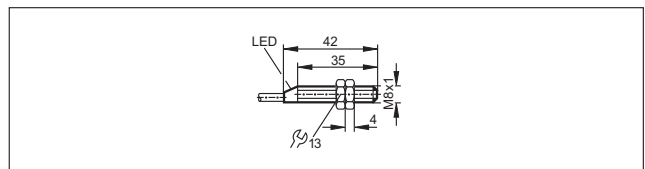

Scale drawings

112

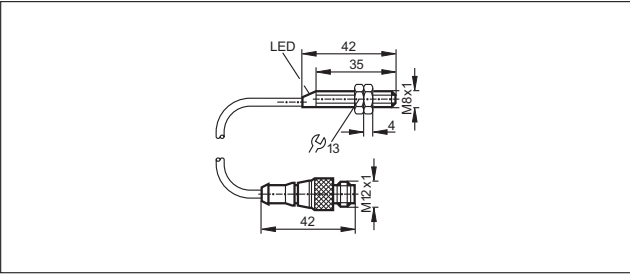

118

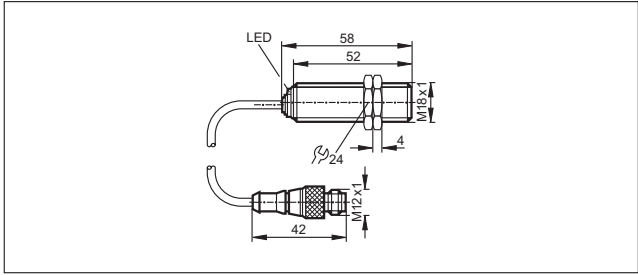

113

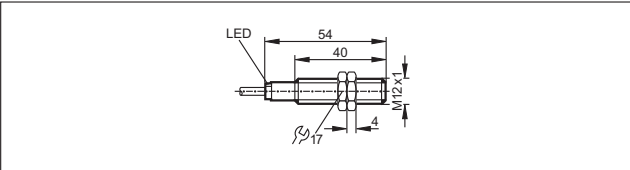

119

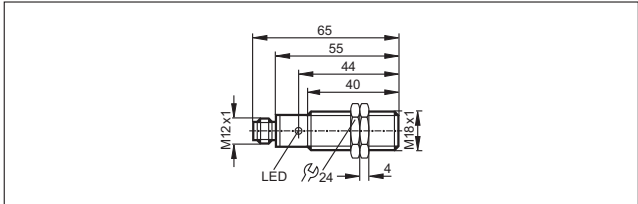

114

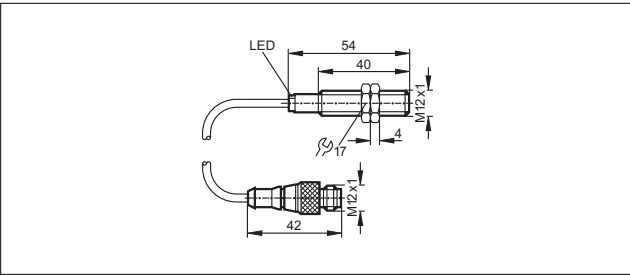

120

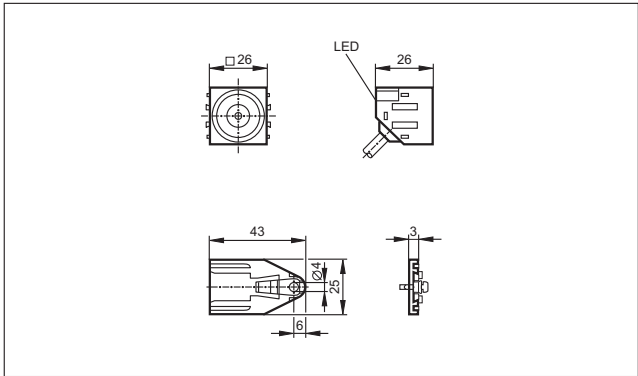

115

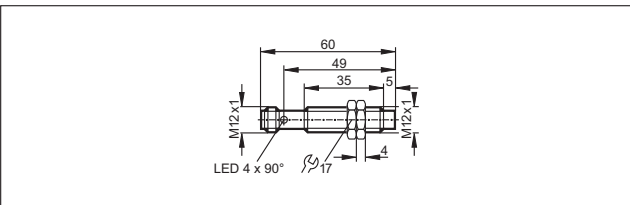

121

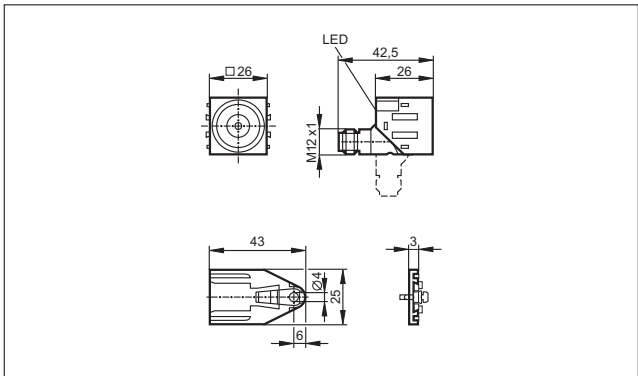

116

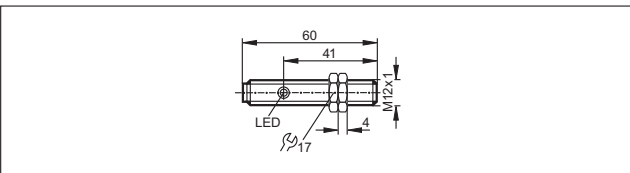

117

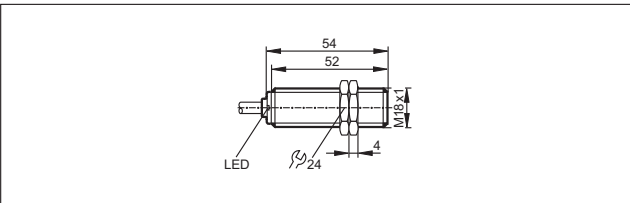

Scale drawings

122

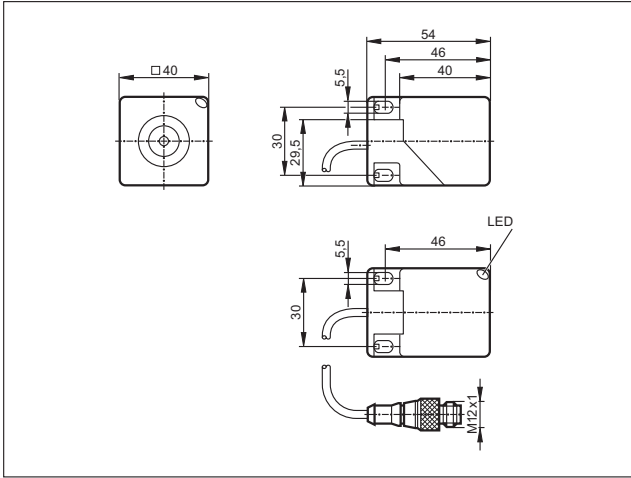

127

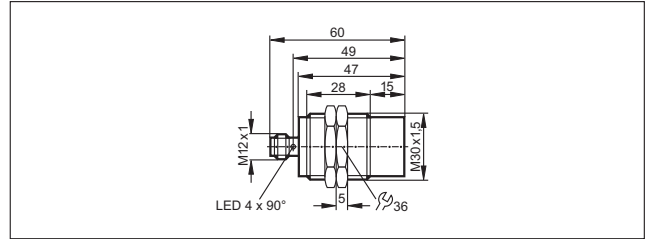

128

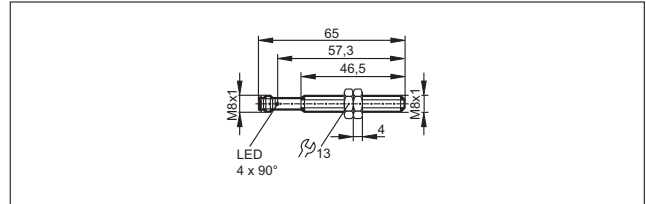

123

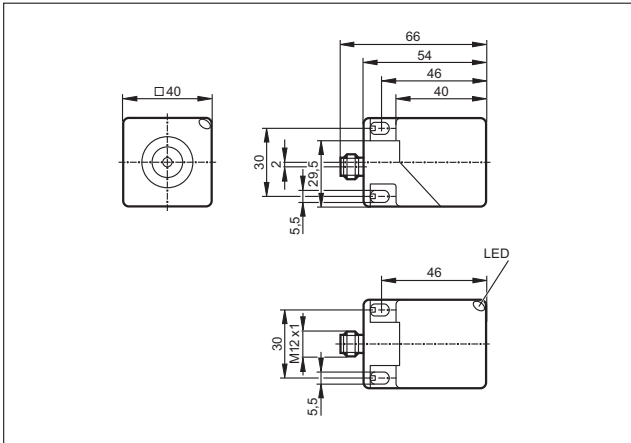

129

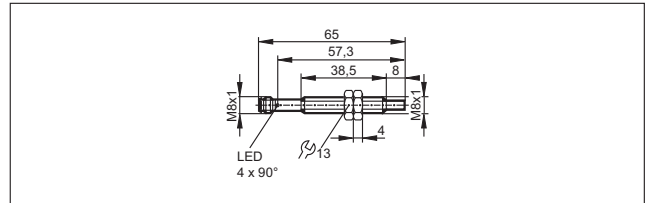

130

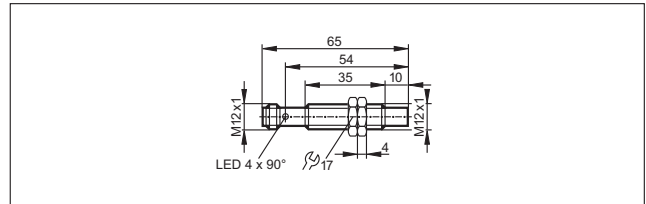

124

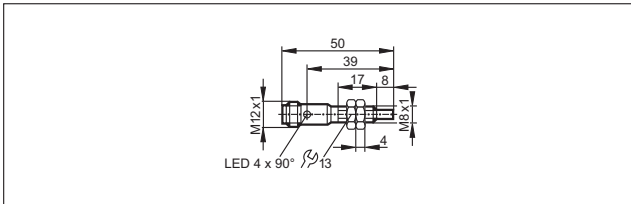

131

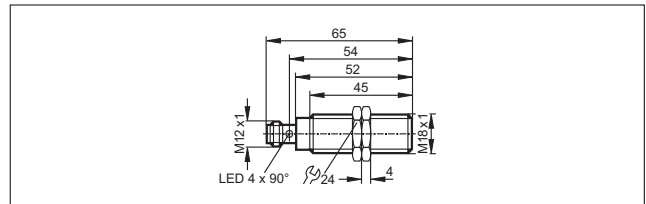

125

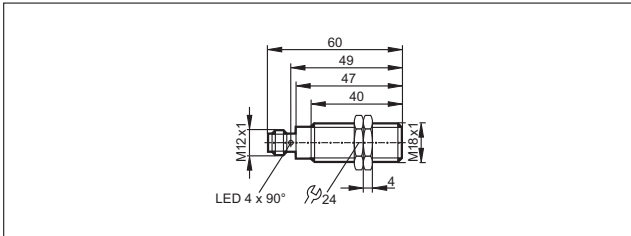

132

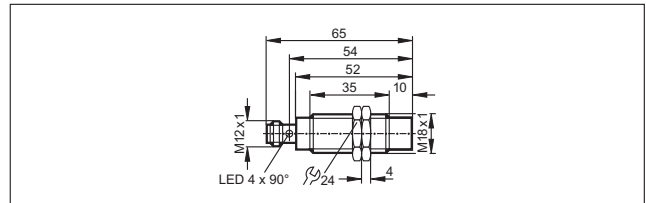

126

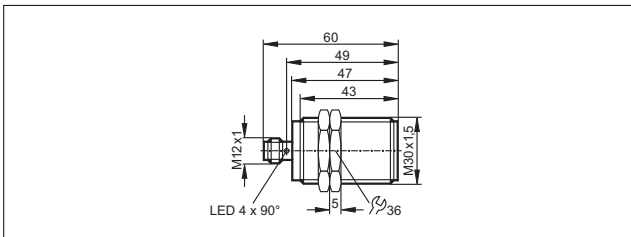

133

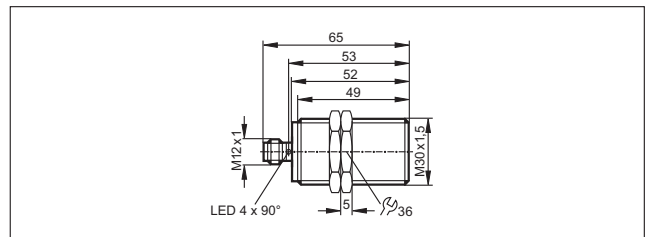

Scale drawings

134

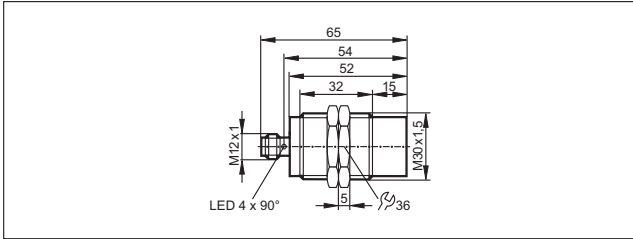

140

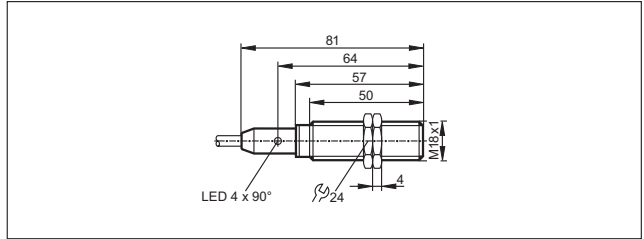

135

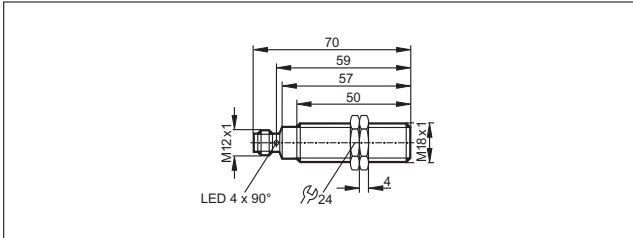

141

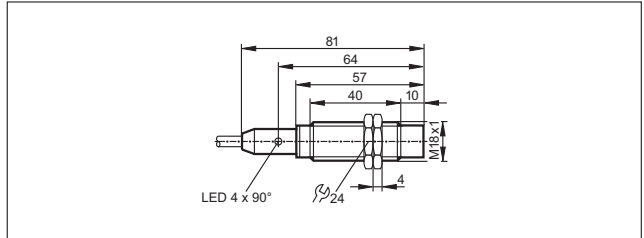

136

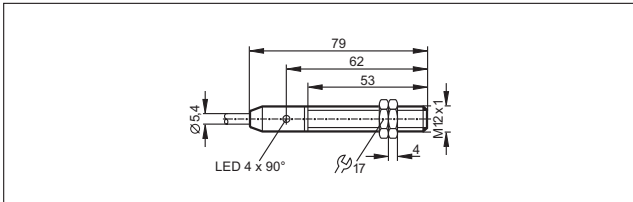

142

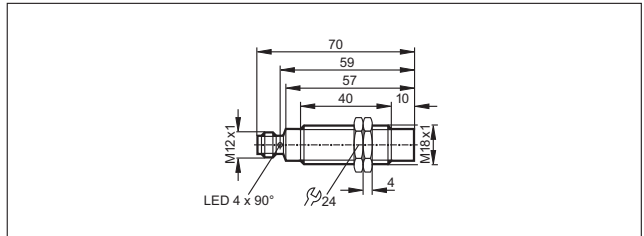

137

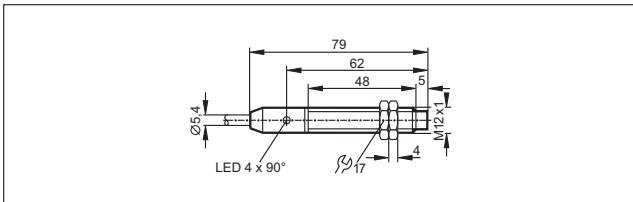

143

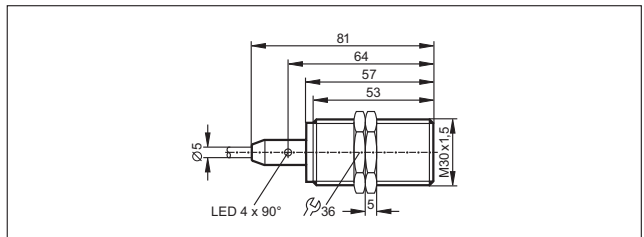

138

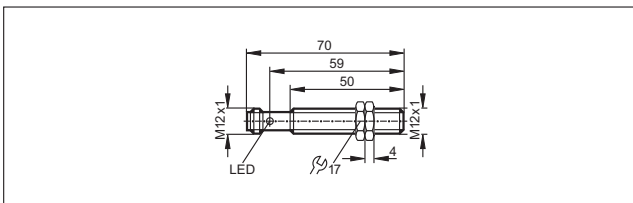

144

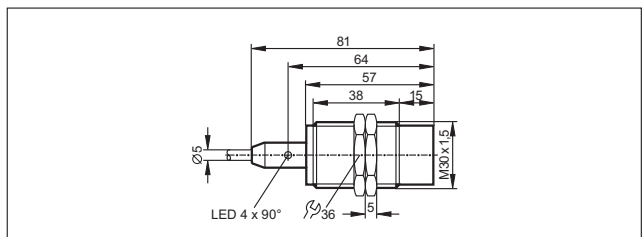

139

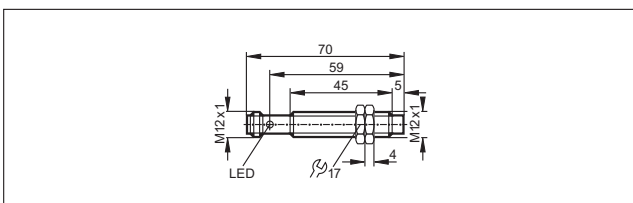

145

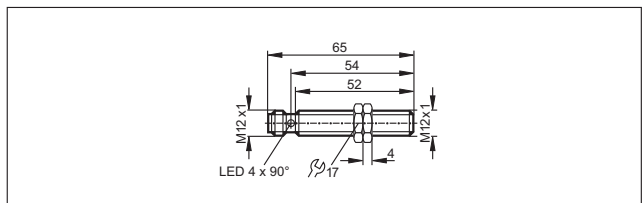

Scale drawings

146

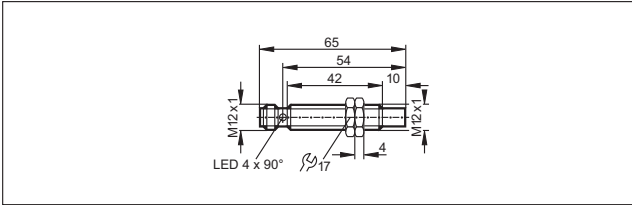

147

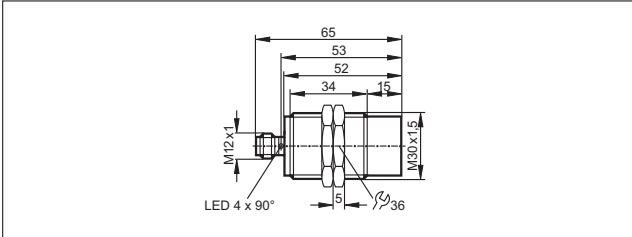

148

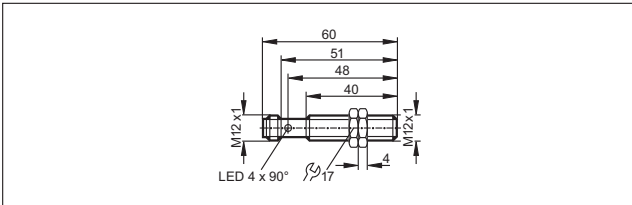

149

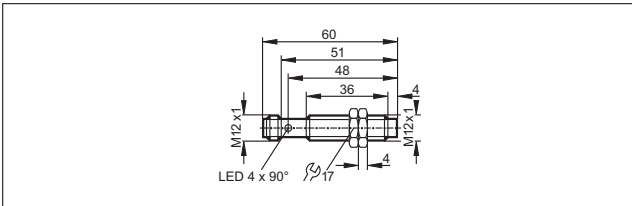

150

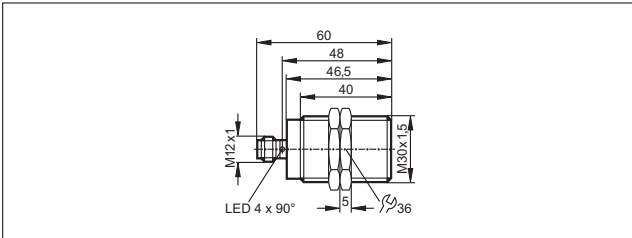

151

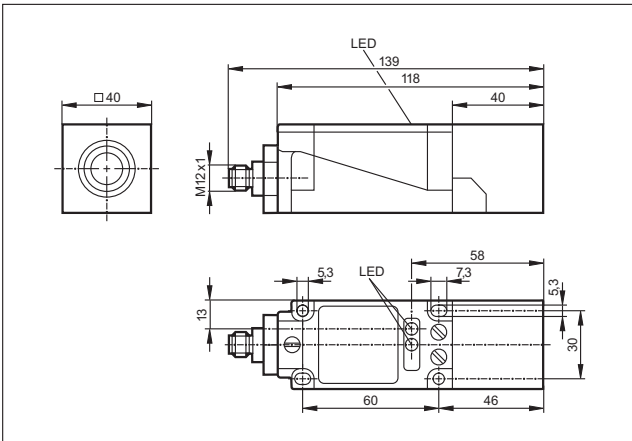

152

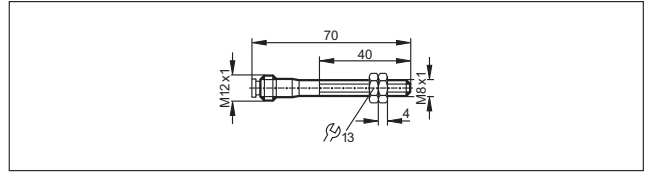

153

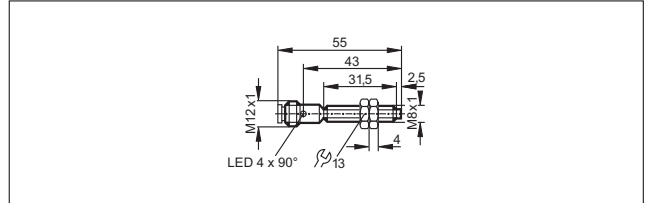

154

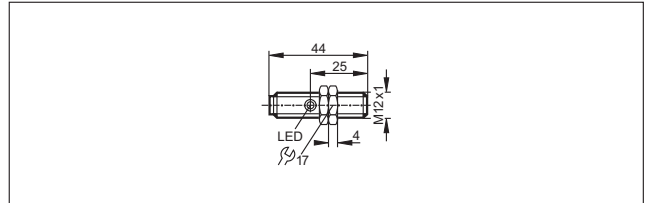

155

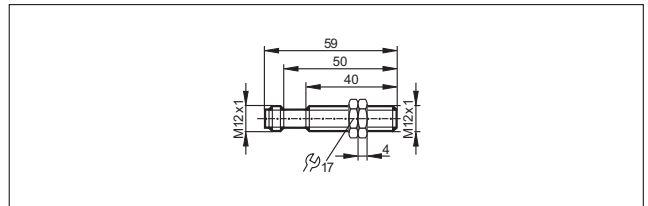

156

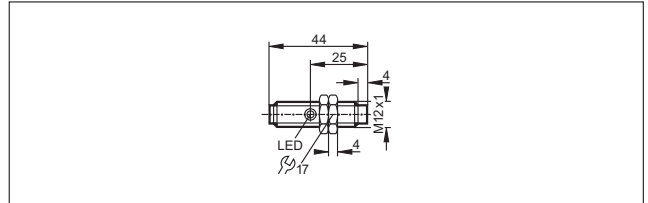

157

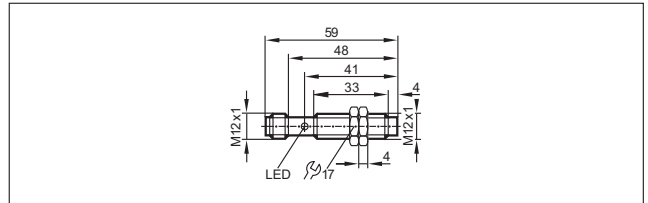

158

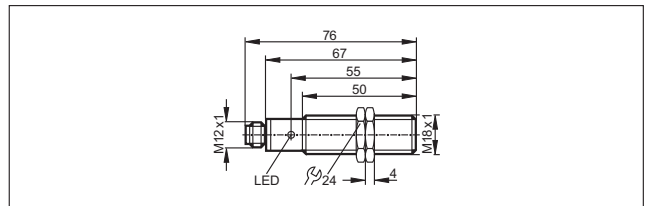

Scale drawings

159

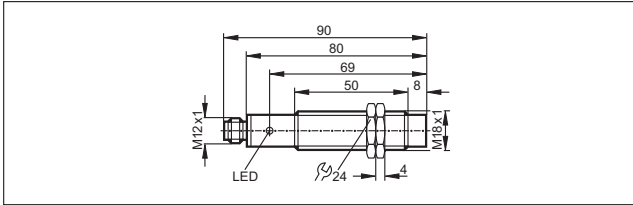

160

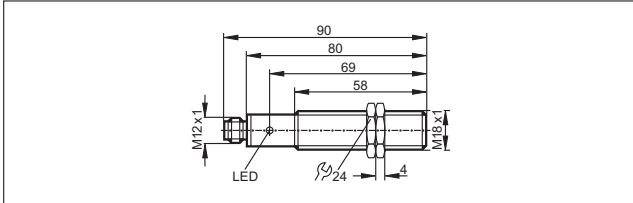

161

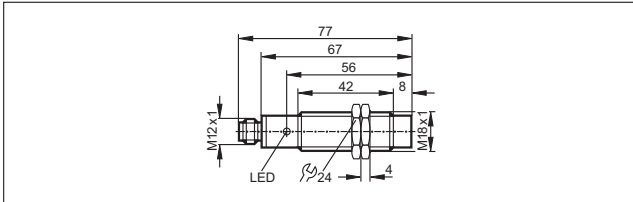

162

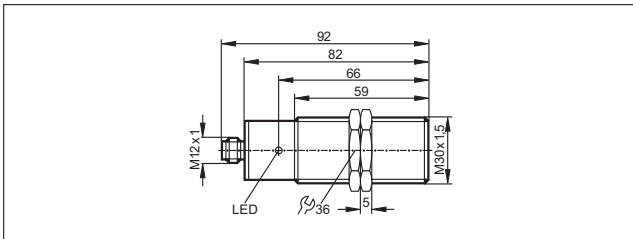

163

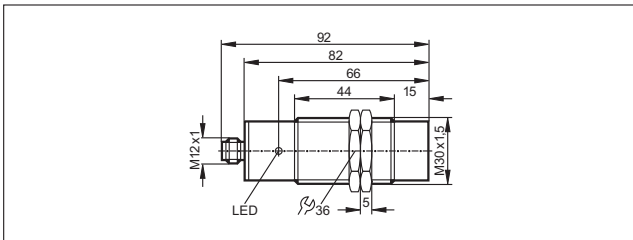

164

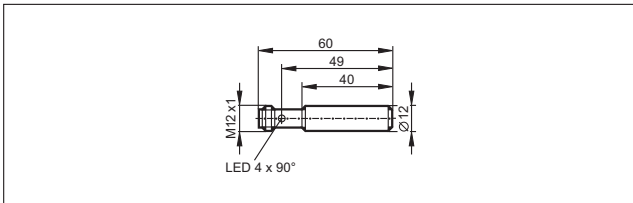

165

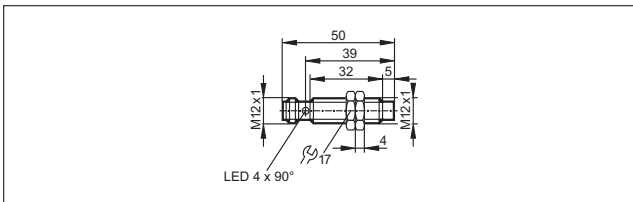

166

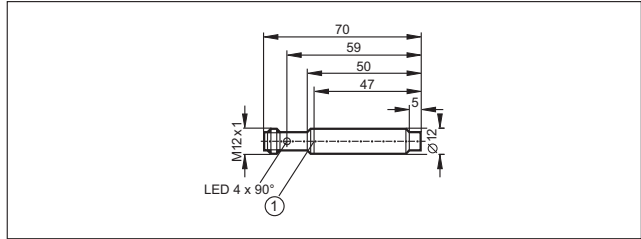

1: locating groove

167

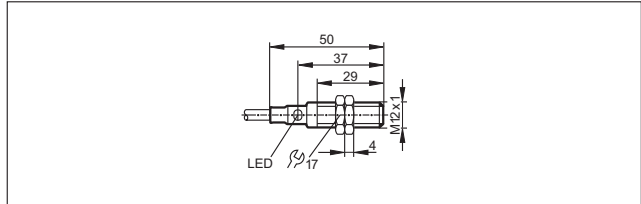

168

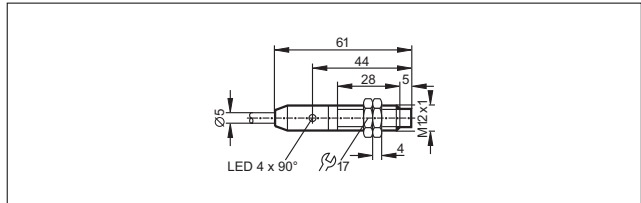

169

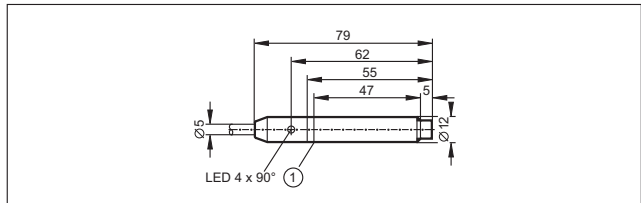

1: locating groove

170

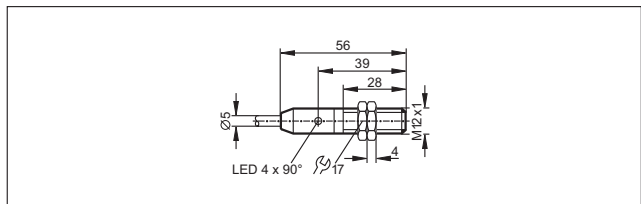

171

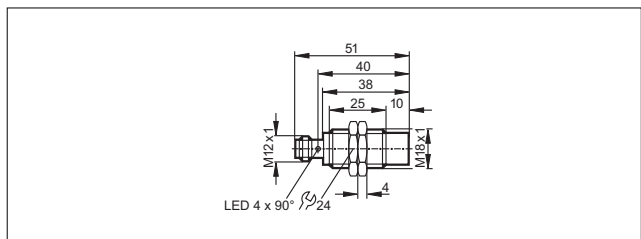

Scale drawings

172

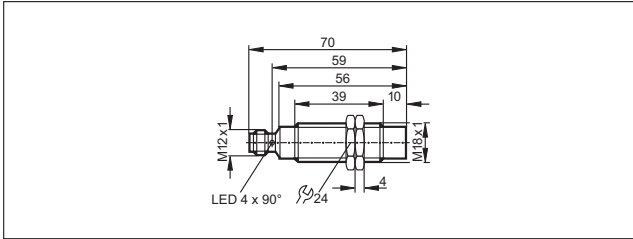

178

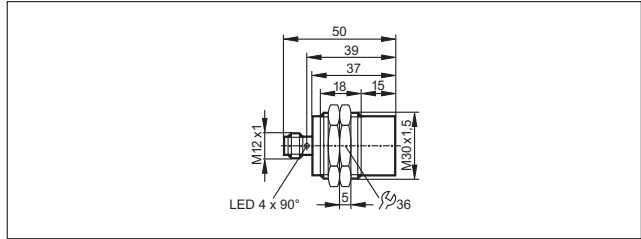

173

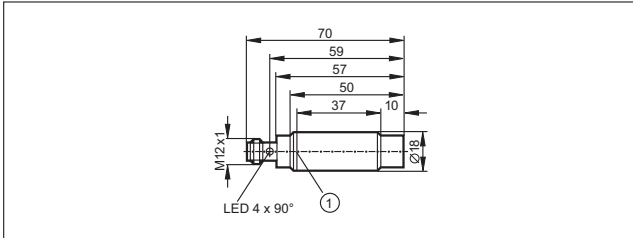

1: locating groove

179

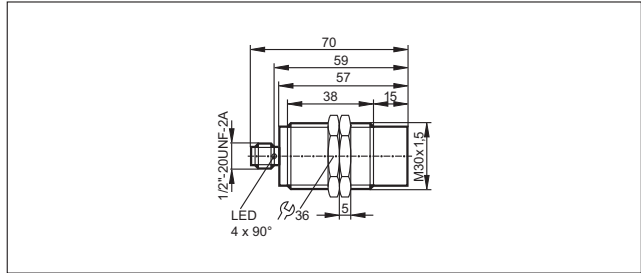

174

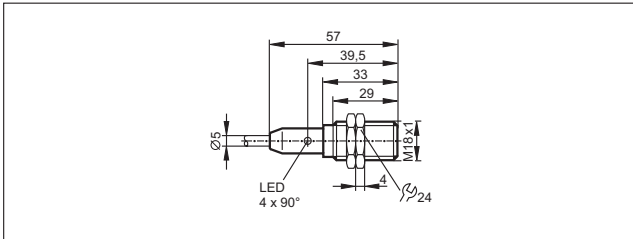

180

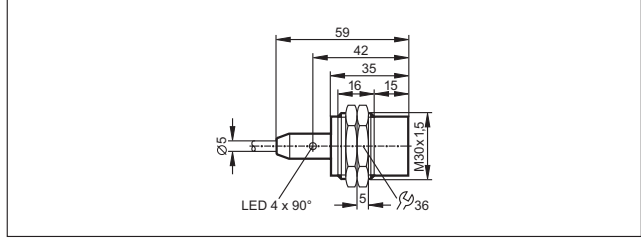

175

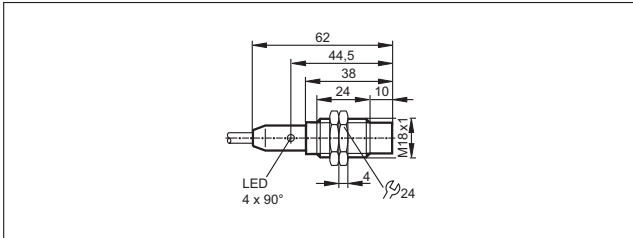

181

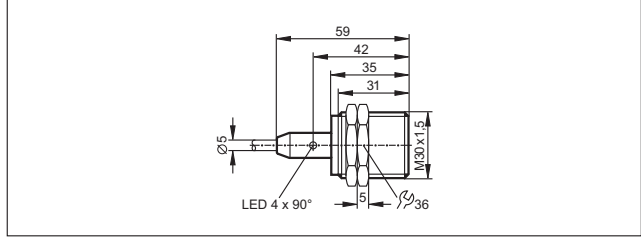

176

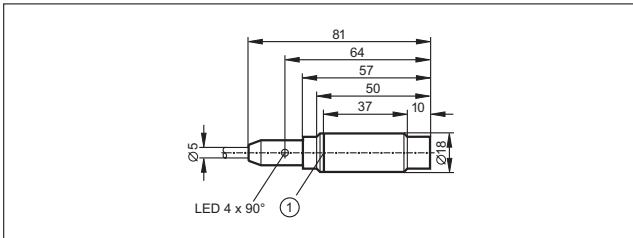

1: locating groove

182

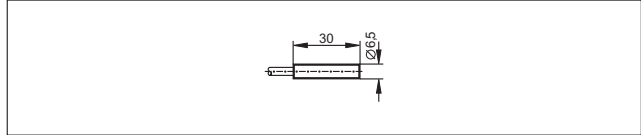

183

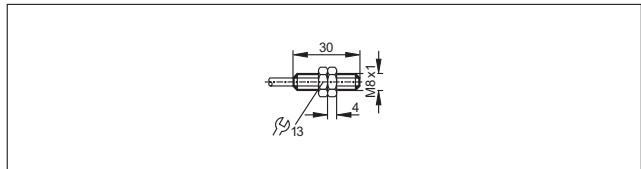

177

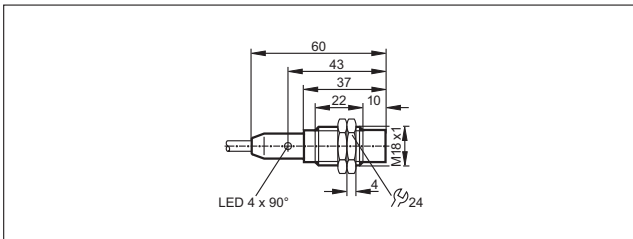

184

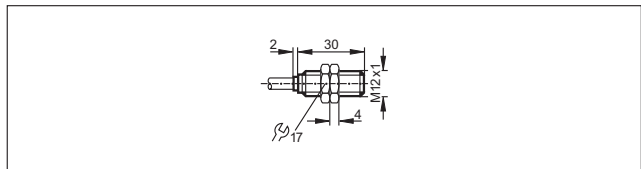

Scale drawings

185

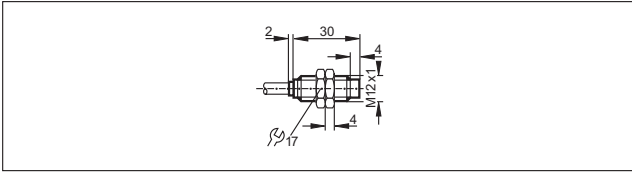

186

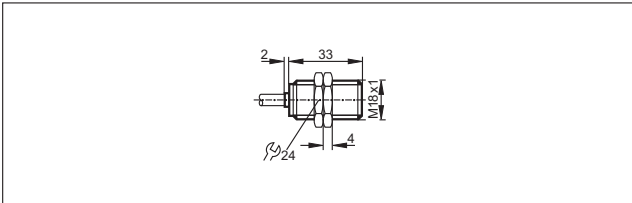

187

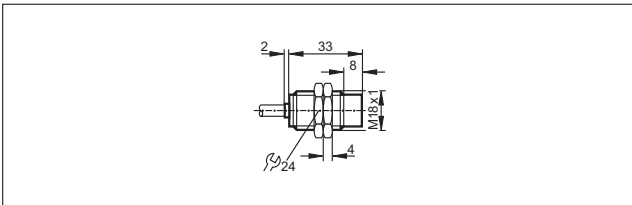

188

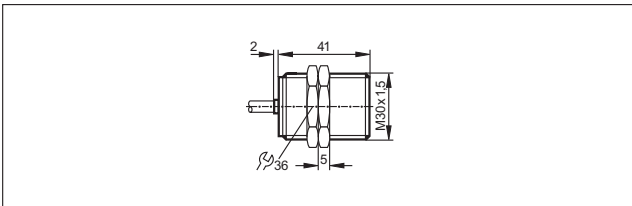

189

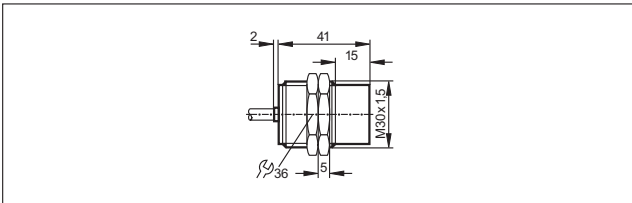

190

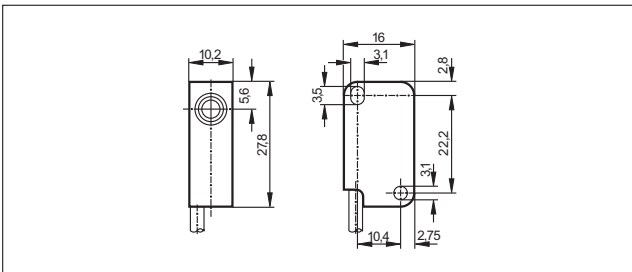

191

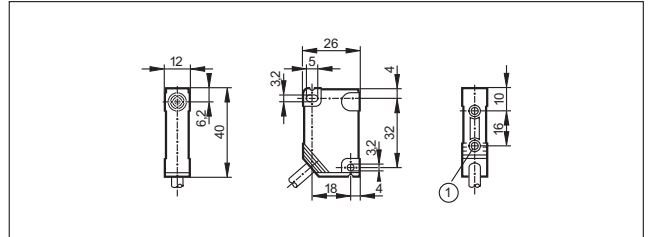

1: threaded insert M3, depth 5.8 mm, max. tightening torque 1.2 Nm (screw fixing class 8.8) when brass insert in contact with counterpart.

192

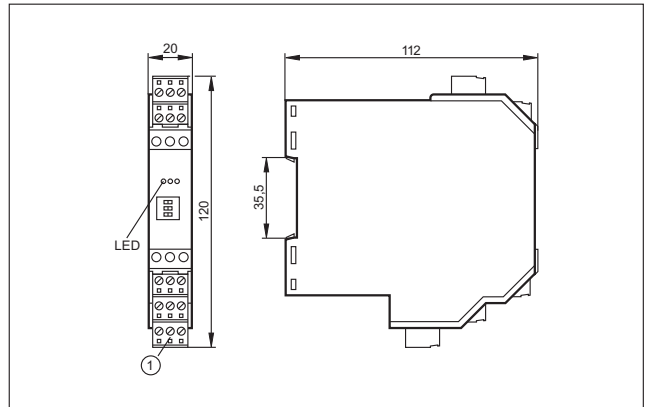

1: Combicon plug with screw terminals (optional)

193

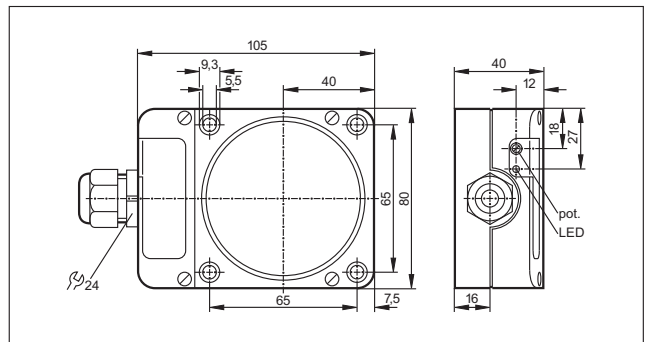

194

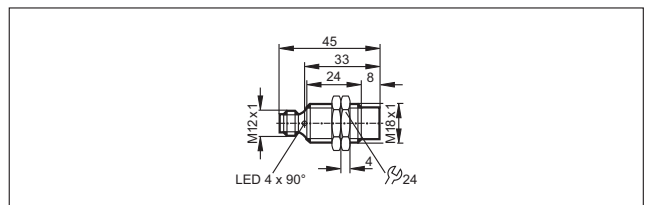

195

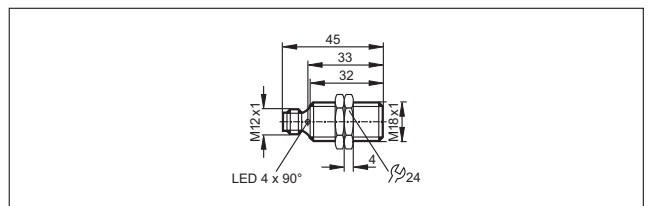

Scale drawings

196

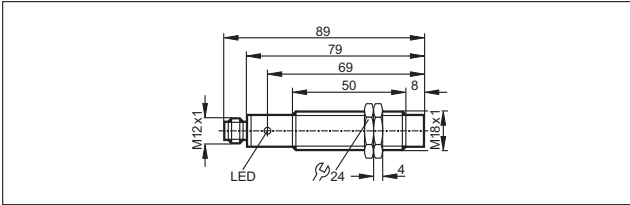

197

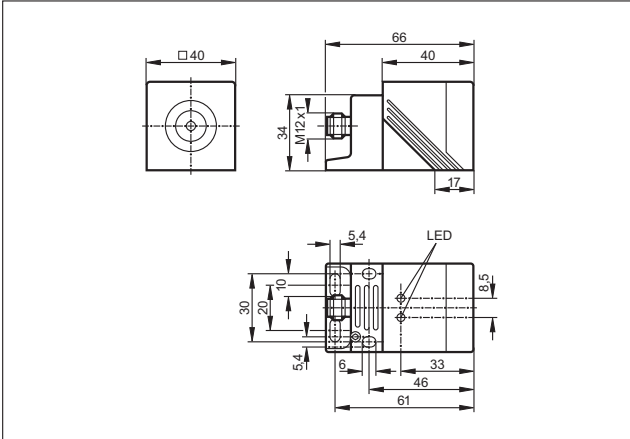

198

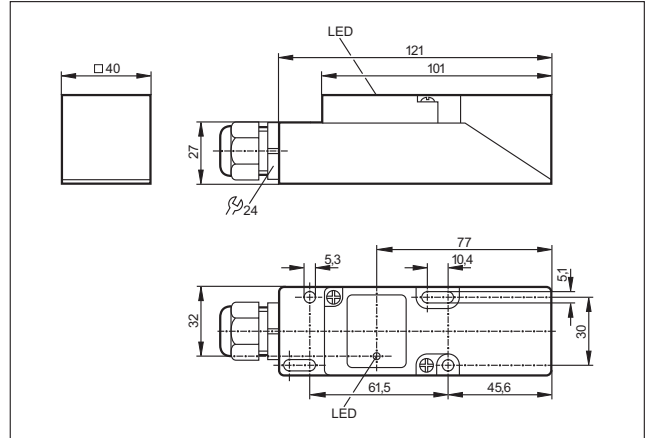

199

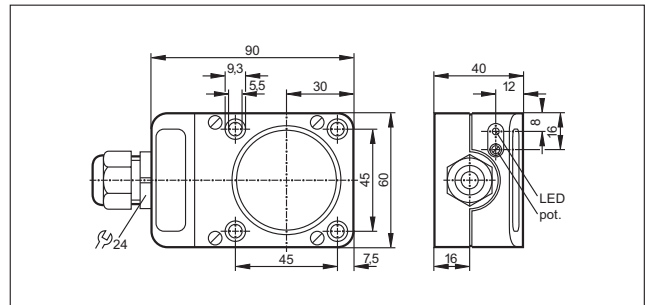



www.ifm.com